

# CATÁLOGO DE PRODUCTOS



# EL NOGAL



\*Este catálogo de productos incluye imágenes de ambiente para ilustrar su uso, pero los productos no incluyen elementos estéticos adicionales. Cabe mencionar que las imágenes pueden no coincidir completamente con el producto real, ya que este es un catálogo en fase beta. Por favor, consulte con su asesor para obtener información precisa. El Nogal no se hace responsable por posibles confusiones derivadas de las imágenes.

● <b><u>PVC</u></b>	<b><u>3</u></b>	● <b><u>CERÁMICAS</u></b>	<b><u>58</u></b>
○ <u>Pvc Presión</u>	<u>4</u>	○ <u>Base Decorada</u>	<u>70</u>
○ <u>Válvulas</u>	<u>6</u>	○ <u>Combo Baños</u>	<u>77</u>
○ <u>Agua Caliente Cpvc - Hotpro</u>	<u>7</u>	○ <u>Decorados</u>	<u>80</u>
○ <u>Sanitaria y Ventilación</u>	<u>8</u>	○ <u>Fachada</u>	<u>87</u>
○ <u>Canales y Bajantes</u>	<u>10</u>	○ <u>Sanitarios</u>	<u>180</u>
○ <u>Rejillas Plásticas</u>	<u>14</u>	○ <u>Lavamanos</u>	<u>93</u>
○ <u>Pegantes</u>	<u>16</u>	○ <u>Listello</u>	<u>104</u>
○ <u>Limpiadores</u>	<u>16</u>	○ <u>Mosaico - muebles - malla</u>	<u>135</u>
○ <u>Eléctrico - Conduflex</u>	<u>16</u>	○ <u>Pared</u>	<u>145</u>
○ <u>Alcantarillado - Novafort</u>	<u>18</u>	○ <u>Piso</u>	<u>158</u>
● <b><u>HIERRO</u></b>	<b><u>24</u></b>	● <b><u>GRIFERIA</u></b>	<b><u>192</u></b>
○ <u>Acero</u>	<u>25</u>	○ <u>Duchas</u>	<u>203</u>
○ <u>Alambres y Mallas</u>	<u>29</u>	○ <u>Desagües</u>	<u>207</u>
● <b><u>PERFILES</u></b>	<b><u>32</u></b>	○ <u>Ducha Electrica</u>	<u>211</u>
○ <u>Tubo Mueble</u>	<u>33</u>	○ <u>Grifos - incrustaciones</u>	<u>214</u>
○ <u>Placa Facil - Tubo Cerram</u>	<u>34</u>	○ <u>Kits - Llaves</u>	<u>218</u>
○ <u>Ángulos</u>	<u>35</u>	○ <u>Mezcladoras y Regaderas</u>	<u>237</u>
○ <u>Perfil en C Canal Paral</u>	<u>39</u>	○ <u>Registros - Repuestos</u>	<u>248</u>
● <b><u>GRES</u></b>	<b><u>40</u></b>	○ <u>Toalleros - Válvulas</u>	<u>252</u>
○ <u>Bloques</u>	<u>41</u>	● <b><u>POLVOS</u></b>	<b><u>258</u></b>
○ <u>Tejas de Barra</u>	<u>44</u>	○ <u>Pegantes</u>	<u>259</u>
○ <u>Fachaleta</u>	<u>45</u>	○ <u>Boquillas</u>	<u>263</u>
○ <u>Enchape</u>	<u>48</u>	○ <u>Concolor</u>	<u>264</u>
○ <u>Guardaescoba - Zocalo</u>	<u>50</u>	○ <u>Yeso</u>	<u>265</u>
○ <u>Escalgres</u>	<u>51</u>	● <b><u>MATERIAL DE ARRASTRE</u></b>	<b><u>266</u></b>
○ <u>Decorados</u>	<u>52</u>	○ <u>Granito (Bultos)</u>	<u>267</u>
● <b><u>CEMENTOS</u></b>	<b><u>58</u></b>	○ <u>Gravilla y Triturado</u>	<u>268</u>
○ <u>Bultos</u>	<u>59</u>	○ <u>Ladrillos de Piedra</u>	<u>269</u>
○ <u>Lavaderos Enchapados</u>	<u>61</u>	○ <u>Arena</u>	<u>270</u>
○ <u>Lavaderos de Granito</u>	<u>62</u>	● <b><u>ACC. ELÉCTRICOS</u></b>	<b><u>271</u></b>
○ <u>Complementos</u>	<u>445</u>	○ <u>Alambres</u>	<u>272</u>
		○ <u>Espiral Coraza</u>	<u>273</u>
		○ <u>Interruptores</u>	<u>279</u>
		○ <u>Plafon Tacos Coaxial</u>	<u>276</u>
		○ <u>Pulsadores Zumbadores</u>	<u>278</u>

●	<u>ACC. PUERTAS</u>	<u>280</u>	●	<u>COCINA</u>	<u>359</u>	
	○	<u>Candados</u>	281	○	<u>Cocinas</u>	360
	○	<u>Cerraduras</u>	284	○	<u>Lavaplatos</u>	361
	○	<u>Cerrojos 22</u>	290	○	<u>Mesones y Pocetas</u>	369
	○	<u>Ojo Mágico - Topes 22</u>	293	●	<u>GALVANIZADO</u>	<u>370</u>
●	<u>ADITIVOS</u>	<u>294</u>	○	<u>Accesorios</u>	371	
	○	<u>Alumol</u>	295	○	<u>Niples galvanizados</u>	375
	○	<u>Limpiadores</u>	297	○	<u>Complementos</u>	445
	○	<u>Sika 1 Sika 101</u>	298	●	<u>MANGUERAS</u>	<u>378</u>
●	<u>TEJAS</u>	<u>310</u>	○	<u>Abrazaderas</u>	379	
	○	<u>Fibro cemento Proteja</u>	311	○	<u>Acoples y Racores</u>	380
	○	<u>Galvanizada</u>	312	○	<u>Mangueras</u>	381
	○	<u>Pvc</u>	314	○	<u>Aspersores y Boquillas</u>	385
	○	<u>Complementos</u>	438	○	<u>Pistolas y Conectores</u>	386
●	<u>SISTEMAS LIVIANOS</u>	<u>325</u>	○	<u>Uniones y Tés</u>	387	
	○	<u>Tablas (paneles) y Masilla</u>	326	●	<u>HERRAJERIA</u>	<u>389</u>
	○	<u>Rollos de Material</u>	327	○	<u>Cargas y Anclajes</u>	390
●	<u>TANQUES</u>	<u>328</u>	○	<u>Grapas y Clavos</u>	391	
	○	<u>Acuaviva Colombit</u>	329	○	<u>Tornillos y Accesorios</u>	395
	○	<u>Colempaques</u>	330	●	<u>HERRAMIENTAS</u>	<u>398</u>
	○	<u>Proco</u>	334	○	<u>Manual</u>	399
	○	<u>La fuente</u>	336	○	<u>Agrícola</u>	404
	○	<u>Complementos</u>	443	○	<u>Complementos TEJAS</u>	437
●	<u>TELAS</u>	<u>139</u>	○	<u>Complementos de Gres</u>	439	
	○	<u>Geotextiles y Mantos</u>	339	○	<u>Complementos Tanques</u>	442
	○	<u>Plásticos y Multisombra</u>	342	○	<u>Complementos Cementos</u>	444
	○	<u>Rollos Especializados</u>	343	○	<u>Complementos Galvanizado</u>	445
	○	<u>Complementos</u>	444	○	<u>Otros Productos</u>	446
●	<u>ELECTRODOMÉSTICOS</u>	<u>345</u>				
	○	<u>Calentadores de Agua</u>	346			
	○	<u>Campanas Extractoras</u>	349			
	○	<u>Cubiertas de Cocina</u>	351			
	○	<u>Hornos</u>	356			
	○	<u>Mesones y Muebles</u>	358			

# PVC

○ <u>Pvc Presión</u>	<u>4</u>
○ <u>Válvulas</u>	<u>6</u>
○ <u>Agua Caliente Cpvc - Hotpro</u>	<u>7</u>
○ <u>Sanitaria y Ventilación</u>	<u>8</u>
○ <u>Canales y Bajantes</u>	<u>10</u>
○ <u>Rejillas Plásticas</u>	<u>14</u>
○ <u>Pegantes</u>	<u>16</u>
○ <u>Limpiadores</u>	<u>16</u>
○ <u>Eléctrico - Conduflex</u>	<u>16</u>
○ <u>Alcantarillado - Novafort</u>	<u>18</u>

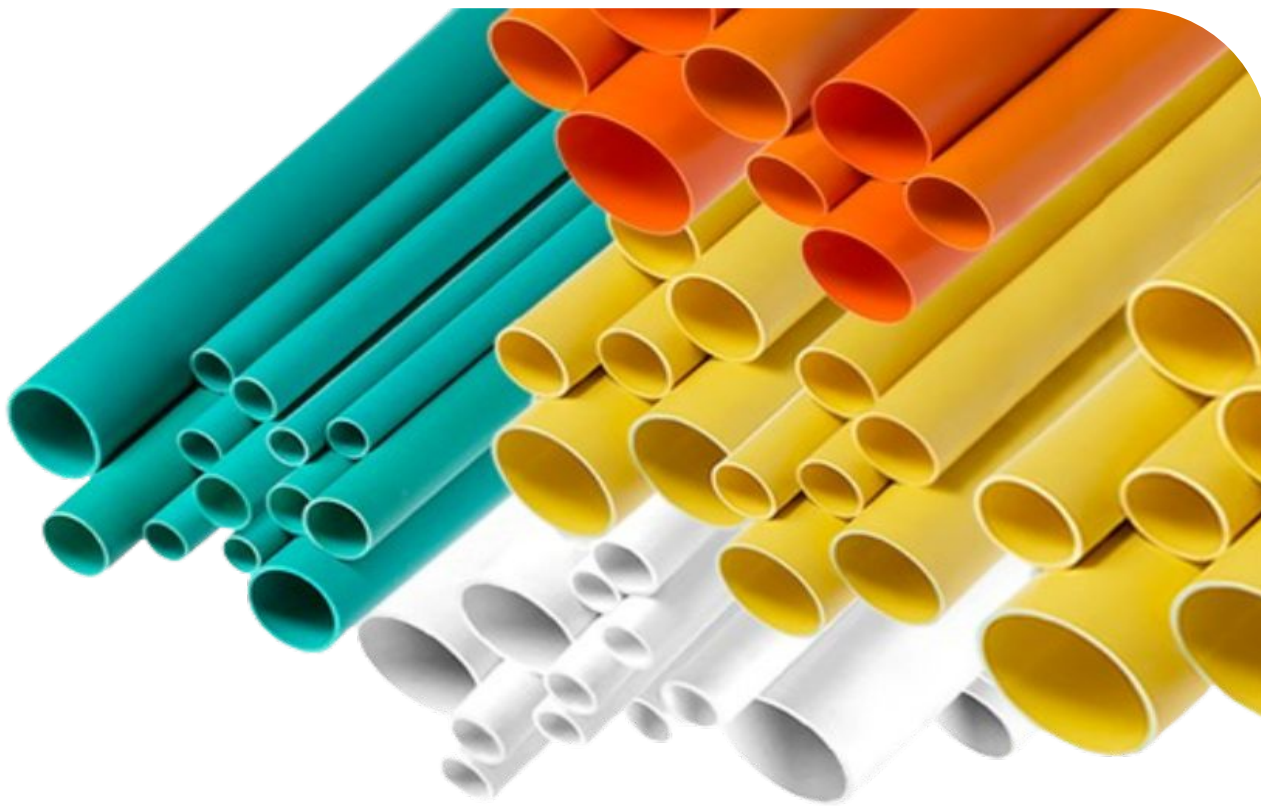

**PAVCO**  
wavin

## PVC PRESIÓN

Sistema de tuberías y Conexiones

### Tuberías

Referencia Diámetro Unidad de  
pulg. empaque

Tb 6 mt RDE 9 - 500 psi	Referencia	Diámetro pulg.	Unidad de empaque
	2900266	½	24 tubos

RDE 11 - 400 psi	Referencia	Diámetro pulg.	Unidad de empaque
	2900210	¾	24 tubos

RDE 13.5 - 315 psi	Referencia	Diámetro pulg.	Unidad de empaque
	2902449	½	24 tubos
	2900213	1	24 tubos

RDE 21 - 200 psi	Referencia	Diámetro pulg.	Unidad de empaque
	2900237	¾	24 tubos
	2900220	1	24 tubos
	2900225	1¼	24 tubos
	2902450	1½	1 tubo
	2902453	2	1 tubo
	2900230	2½	1 tubo
	2900233	3	1 tubo
	2900240	4	1 tubo
	2904616	6	1 tubo

RDE 26 - 160 psi	Referencia	Diámetro pulg.	Unidad de empaque
	2900246	2	1 tubo
	2900251	3	1 tubo

### Conexiones SCH 40

Referencia Diámetro Unidad de  
pulg. empaque

Tees reducidas	Referencia	Diámetro pulg.	Unidad de empaque
	2901538	¾ x ½	200 ud
	2901530	1 x ½	100 ud
	2901532	1 x ¾	100 ud

Referencia Diámetro Unidad de  
pulg. empaque

Codos 90°	Referencia	Diámetro pulg.	Unidad de empaque
	2901122	½	500 ud
	2901144	¾	250 ud
	2901105	1	200 ud
	2901114	1¼	150 ud
	2901110	1½	100 ud
	2901127	2	25 ud
	2901132	2½	25 ud
	2901137	3	25 ud
	2901149	4	10 ud

Codos 45°	Referencia	Diámetro pulg.	Unidad de empaque
	2901074	½	500 ud
	2901096	¾	250 ud
	2901064	1	200 ud
	2901073	1¼	150 ud
	2901069	1½	100 ud
	2901083	2	25 ud
	2901087	2½	25 ud
	2901090	3	25 ud
	2901100	4	10 ud

Uniones	Referencia	Diámetro pulg.	Unidad de empaque
	2901635	½	1000 ud
	2901661	¾	500 ud
	2901616	1	200 ud
	2901626	1¼	100 ud
	2901621	1½	100 ud
	2901642	2	100 ud
	2901647	2½	25 ud
	2901654	3	50 ud
	2901667	4	20 ud

Adaptadores macho	Referencia	Diámetro pulg.	Unidad de empaque
	2900779	½	1000 ud
	2900802	¾	500 ud
	2900762	1	200 ud
	2900771	1¼	100 ud
	2900767	1½	100 ud
	2900784	2	100 ud
	2900790	2½	25 ud
	2900794	3	25 ud
	2900807	4	20 ud

Tees	Referencia	Diámetro pulg.	Unidad de empaque
	2901498	½	100 ud
	2901519	¾	50 ud
	2901481	1	20 ud
	2901490	1¼	10 ud
	2901486	1½	1 ud
	2901503	2	1 ud
	2901508	2½	1 ud
	2901513	3	1 ud
	2901524	4	1 ud

Universales	Referencia	Diámetro pulg.	Unidad de empaque
	2901679	½	100 ud
	2901685	¾	100 ud
	2901672	1	50 ud
	2901801	1¼	20 ud
	2901802	1½	15 ud
	2901800	2	12 ud

## ACCESORIOS ROSCADOS

	Referencia	Diámetro pulg.	Unidad de empaque
<b>Adaptadores hembra</b> 	2900714	½	1000 ud
	2900740	¾	500 ud
	2900698	1	200 ud
	2900706	1¼	100 ud
	2900702	1½	100 ud
	2900724	2	100 ud
	2900728	2½	25 ud
	2900733	3	50 ud
	2900749	4	20 ud

	Referencia	Diámetro pulg.	Unidad de empaque
<b>Tapones soldados</b> 	2901390	½	500 ud
	2901427	¾	300 ud
	2901359	1	250 ud
	2901377	1¼	200 ud
	2901369	1½	100 ud
	2901400	2	50 ud
	2901406	2½	25 ud
	2901415	3	50 ud
	2901435	4	20 ud

	Referencia	Diámetro pulg.	Unidad de empaque
<b>Bujes soldados</b> 	2900995	¾ x ½	500 ud
	2900849	1 x ½	500 ud
	2900858	1 x ¾	250 ud
	2900906	1¼ x ½	200 ud
	2900914	1¼ x ¾	200 ud
	2900898	1¼ x 1	200 ud
	2900882	1½ x ½	200 ud
	2900890	1½ x ¾	200 ud
	2900866	1½ x 1	200 ud
	2900875	1½ x 1¼	200 ud
	2900952	2 x ½	100 ud
	2900959	2 x ¾	100 ud
	2900928	2 x 1	100 ud
	2900945	2 x 1¼	100 ud
	2900937	2 x 1½	100 ud
	2900966	2 ½ x 1½	50 ud
	2900971	2½ x 2	50 ud
	2900979	3 x 2	50 ud
	2900986	3 x 2½	50 ud
	2901003	4 x 2	25 ud
	2901009	4 x 2½	25 ud
	2901014	4 x 3	25 ud

	Referencia	Diámetro pulg.	Unidad de empaque
<b>Tapones roscados</b> 	2901388	½	500 ud
	2901425	¾	300 ud
	2901357	1	200 ud
	2901375	1¼	200 ud
	2901367	1½	100 ud
	2901398	2	50 ud
	2901405	2½	25 ud
	2901414	3	50 ud
	2901434	4	20 ud

Referencia Diámetro pulg. Unidad de empaque

	Referencia	Diámetro pulg.	Unidad de empaque
<b>Unión reparación deslizante PVC</b> 	2903399	½	100 ud
	2903401	¾	100 ud
	2903397	1	50 ud
	2903398	1½	50 ud
	2903400	2	50 ud

	Referencia	Diámetro pulg.	Unidad de empaque
<b>Bujes roscados</b> 	2900921	½ x 3/8	500 ud
	2900990	¾ x ½	500 ud
	2900846	1 x ½	250 ud
	2900854	1 x ¾	250 ud
	2900903	1¼ x ½	200 ud
	2900910	1¼ x ¾	200 ud
	2900895	1¼ x 1	200 ud
	2900878	1½ x ½	200 ud
	2900887	1½ x ¾	200 ud
	2900863	1½ x 1	200 ud
	2900871	1½ x 1¼	200 ud
	2900950	2 x ½	100 ud
	2900956	2 x ¾	100 ud
	2900924	2 x 1	100 ud
	2900942	2 x 1¼	100 ud
	2900933	2 x 1½	100 ud
	2900976	3 x 2	50 ud

## Accesorios roscados

Referencia Diámetro pulg. Unidad de empaque

	Referencia	Diámetro pulg.	Unidad de empaque
<b>Codo roscado - Soldado</b> 	2901791	90 x ½	90 ud

	Referencia	Diámetro pulg.	Unidad de empaque
<b>Niple roscado</b> 	2901792	½	200 ud

	Referencia	Diámetro pulg.	Unidad de empaque
<b>Tapón roscado</b> 	2901793	½	300 ud

	Referencia	Diámetro pulg.	Unidad de empaque
<b>Tee roscada</b> 	2901808	½	100 ud

## VÁLVULA

Válvulas de Cierre y registro de control

### VÁLVULA DE BOLA H2OFF

	Referencia	Diámetro pulg.	Unidad de empaque	Referencia	Diámetro pulg.	Unidad de empaque	
<b>Soldada</b> 	2903490	½	240 ud	<b>Roscada</b> 	2903489	½	240 ud
	2903492	¾	120 ud		2903491	¾	120 ud
	2903494	1	80 ud		2903493	1	80 ud
	2903329	1¼	24 ud		2903338	1¼	24 ud
	2903339	1½	40 ud		2903337	1½	18 ud
	2903640	2	20 ud		2903639	2	20 ud
<b>Paso Boca Eco Soldada</b> 	0005919	1		<b>Lin Pesada Azul</b> 	0005922	1	
	0005935	1½			0005923	1	
					0005938	1½	
					0005939	1½	
					0005946	¾	
					0005947	¾	

### VALVULA AGUA CALIENTE

	Referencia	Diámetro pulg.	Unidad de empaque
<b>Válvulas bola</b> 	2910426	½	1 ud
	2910427	¾	1 ud
	2910428	1	1 ud

Aspersor ½ x 14 Ros NPT Boq Verde PCP

Boquilla Rociadora Antideslizante

Boquilla Rociadora Eco PCP

Conector en Y Amarillo PCP



## CPVC - HOTPRO

Sistema de tuberías  
y conexiones para agua caliente

### Tuberías

Referencia Diámetro Unidad de  
pulg. empaque

Tuberías RDE 11			
Presión de Trabajo 100 psi a 82°C (Tamaño Cobre) 3 metros			
	2910217	½	48 tubos
	2910219	¾	48 tubos
	2910221	1	24 tubos

Tuberías RDE 11			
Presión de Trabajo 100 psi a 82°C (Tamaño Cobre) 6 metros			
	2910222	1¼	1 tubo
	2910223	1½	1 tubo
	2910224	2	1 tubo

### Conexiones

Referencia Diámetro Unidad de  
o pulg. empaque

Tees			
	2910396	½	500 ud
	2910397	¾	200 ud
	2910398	1	100 ud
	2910399	1¼	1 ud
	2910400	1½	1 ud
	2903765	2*	1 ud

Codo 90°			
	2910372	½	500 ud
	2910373	¾	300 ud
	2910374	1	100 ud
	2910375	1¼	1 ud
	2910377	1½	1 ud
	2903756	2	1 ud

Codo 45°			
	2910360	½	200 ud
	2910361	¾	200 ud
	2910363	1	100 ud
	2910364	1¼	1 ud
	2910365	1½	1 ud
	2903753	2	1 ud

Referencia Diámetro Unidad de  
o pulg. empaque

Uniones			
	2910408	½	500 ud
	2910409	¾	200 ud
	2910410	1	100 ud
	2910411	1¼	1 ud
	2910412	1½	1 ud
	2903768	2	1 ud

Adaptadores roscado macho			
	2910331	½	500 ud
	2910332	¾	200 ud
	2910333	1	100 ud
	2910334	1¼	1 ud
	2910335	1½	1 ud
	2903734	2	1 ud

Adaptadores roscado hembra			
	2910328	½	400 ud
	2910329	¾	200 ud

Tapones soldados			
	2910385	½	500 ud
	2910386	¾	200 ud
	2910387	1	100 ud
	2910388	1¼	1 ud
	2910389	1½	1 ud
	2903759	2	1 ud

Unión Universal			
	2910421	½	100 ud
	2910422	¾	100 ud

Bujes soldados			
	2910350	¾ x ½	500 ud
	2910352	1 x ½	100 ud
	2910354	1 x ¾	100 ud
	2903735	1¼ x ½	1 ud
	2903736	1¼ x ¾	1 ud
	2910355	1¼ x 1	1 ud
	2903742	1½ x ½	1 ud
	2903743	1½ x ¾	1 ud
	2910356	1½ x 1	1 ud
	2910357	1½ x 1¼	1 ud
	2903746	2 x ½	1 ud
	2903747	2 x ¾	1 ud
	2903748	2 x 1	1 ud
	2903749	2 x 1¼	1 ud
	2903750	2 x 1½	1 ud



## Sanitaria y Ventilación

### Sistema de tuberías y conexiones

#### Tuberías

Referencia Diámetro o pulg. Unidad de empaque

Tuberías Sanitaria Tramos de 6 metros	Referencia	Diámetro o pulg.	Unidad de empaque
	2900319	1½	1 tubo
	2902515	2	1 tubo
	2902517	3	1 tubo
	2900331	4	1 tubo
	2900336	6	1 tubo
	2900420	8	1 tubo
	2900421	10	1 tubo

Tubería Ventilación	Referencia	Diámetro o pulg.	Unidad de empaque
	2900338	1½	1 tubo
	2900341	2	1 tubo
	2900344	3	1 tubo
	2900347	4	1 tubo

#### Conexiones

Referencia Diámetro pulg. Unidad de empaque

Codos 90° - ¼ C x C	Referencia	Diámetro pulg.	Unidad de empaque
	2901209	1½	100 ud
	2901213	2	50 ud
	2901217	3	20 ud
	2901221	4	10 ud
	2901224	6	1 ud
	2909777	8*	1 ud
	2903802	10*	1 ud

\* Color blanco.

Codos 90° - ¼ C x E	Referencia	Diámetro pulg.	Unidad de empaque
	2901210	1½	1 ud
	2901214	2	1 ud
	2901218	3	1 ud
	2901222	4	1 ud
	2901226	6	1 ud

Referencia Diámetro o pulg. Unidad de empaque

Codos 45° - 1/8 C x C	Referencia	Diámetro o pulg.	Unidad de empaque
	2901179	1½	50 ud
	2901181	2	100 ud
	2901185	3	50 ud
	2901189	4	20 ud
	2901193	6	1 ud
	2909776	8*	1 ud
	2903804	10*	1 ud

Codos 45° - 1/8 C x E	Referencia	Diámetro o pulg.	Unidad de empaque
	2901180	1½	50 ud
	2901183	2	50 ud
	2901187	3	25 ud
	2901191	4	20 ud
	2901195	6	1 ud
	2903805	8*	1 ud
	2903806	10*	1 ud

Codos 22½° - 1.1/16 C x C	Referencia	Diámetro o pulg.	Unidad de empaque
	2901162	2	50 ud
	2901164	3	20 ud
	2901167	4	20 ud
	2903450	6	1 ud

Codos 22½° - 1/16 C x E	Referencia	Diámetro o pulg.	Unidad de empaque
	2901163	2	50 ud
	2901165	3	20 ud
	2901168	4	20 ud

Codos reventados	Referencia	Diámetro o pulg.	Unidad de empaque
	2901156	3 x 2	25 ud
	2901157	4 x 2	10 ud

Tees Sanitarias	Referencia	Diámetro o pulg.	Unidad de empaque
	2901558	1½	100 ud
	2901561	2	50 ud
	2901563	3	20 ud
	2901567	4	10 ud
	2911125	6	1 ud
	2903799	8*	1 ud
	2903800	10*	1 ud

\* Color blanco.

	Referencia	Diámetro pulg.	Unidad de empaque
<b>Tees Sanitarias reducidas</b> 	2901543	2 x 1½	25 ud
	2901545	3 x 2	25 ud
	2901548	4 x 2	20 ud
	2901550	4 x 3	10 ud
	2911128	6 x 4	1 ud

	Referencia	Diámetro pulg.	Unidad de empaque
<b>Tees sanitarias dobles</b> 	2901469	1½	25 ud
	2901471	2	25 ud
	2901473	3	10 ud
	2901476	4	5 ud

	Referencia	Diámetro pulg.	Unidad de empaque
<b>Tees sanitarias dobles reducidas</b> 	2901460	2 x 1½	20 ud
	2901462	3 x 2	20 ud
	2901464	4 x 2	10 ud
	2901466	4 x 3	10 ud

	Referencia	Diámetro pulg.	Unidad de empaque
<b>Yees Sanitarias</b> 	2901748	2	50 ud
	2901751	3	20 ud
	2901755	4	10 ud
	2901758	6	1 ud
	2903794	8*	1 ud
	2903798	10*	1 ud

	Referencia	Diámetro pulg.	Unidad de empaque
<b>Yees Sanitarias reducidas</b> 	2901738	3 x 2	25 ud
	2901741	4 x 2	20 ud
	2901743	4 x 3	10 ud
	2901716	6 x 4	1 ud
	2903792	8 x 4	1 ud
	2903793	8 x 6	1 ud
	2903795	10 x 4	1 ud
	2903796	10 x 6	1 ud
	2903797	10 x 8	1 ud

	Referencia	Diámetro pulg.	Unidad de empaque
<b>Yees sanitarias dobles</b> 	2901729	2	25 ud
	2901731	3	10 ud
	2901734	4	5 ud

	Referencia	Diámetro pulg.	Unidad de empaque
<b>Yees Sanitarias dobles reducidas</b> 	2901721	2 x 3 x 2	20 ud
	2901724	2 x 4 x 2	10 ud
	2901726	3 x 4 x 3	5 ud

	Referencia	Diámetro pulg.	Unidad de empaque
<b>Uniones</b> 	2901690	1½	100 ud
	2901693	2	100 ud
	2901696	3	50 ud
	2901700	4	25 ud
	2901703	6	5 ud
	2909778	8*	1 ud
	2903817	10*	1 ud

	Referencia	Diámetro pulg.	Unidad de empaque
<b>Bujes soldados</b> 	2901021	2 x 1½	200 ud
	2901026	3 x 1½	100 ud
	2901028	3 x 2	100 ud
	2901030	4 x 2	50 ud
	2901033	4 x 3	50 ud
	2901036	6 x 4	20 ud
	2903811	8 x 4	1 ud
	2909775	8 x 6	1 ud
	2903813	10 x 6	1 ud
	2903814	10 x 8	1 ud

	Referencia	Diámetro pulg.	Unidad de empaque
<b>Adaptadores de limpieza</b> 	2900678	2	100 ud
	2900680	3	50 ud
	2900682	4	25 ud
	2900686	6	20 ud
	2905389	8*	1 ud
	2905390	10*	1 ud

	Referencia	Diámetro pulg.	Unidad de empaque
<b>Juntas de expansión</b> 	2901258	3	20 ud
	2901260	4	10 ud
	2902730	6	1 ud

	Referencia	Diámetro pulg.	Unidad de empaque
<b>Junta de expansión de dos cuerpos (Unión de reparación 4)</b> 	2901688	4	25 ud
	2909174	3	25 ud

Referencia Diámetro  
o pulg. Unidad de  
empaque

Tapones de prueba	Referencia	Diámetro o pulg.	Unidad de empaque
	2901437	1½	100 ud
	2901439	2	100 ud
	2901441	3	100 ud
	2901443	4	100 ud
	2905559	6	1 ud
	2903809	8*	1 ud
	2903810	10*	1 ud

## Sifones

Referencia Diámetro  
o pulg. Unidad de  
empaque

Sifones con tapón	Referencia	Diámetro o pulg.	Unidad de empaque
	2901286	1½	50 ud
	2901292	2	50 ud

Sifón 180° No incluye codo	Referencia	Diámetro o pulg.	Unidad de empaque
	2901291	2	50 ud

Sifones 135° No incluye codo	Referencia	Diámetro o pulg.	Unidad de empaque
	2901281	3	20 ud
	2901283	4	5 ud

## Canales y Bajantes

Amazona y Raingo

### Canal Amazona

Referencia Unidad de  
empaque

Canal Amazona Tramos de 3 metros Blanca	Referencia	Unidad de empaque
	2900115	4 ud

## Conexiones Canal Amazona

Referencia Unidad de  
empaque

Unión canal	Referencia	Unidad de empaque
	2901582	25 ud

Unión canal a bajante Amazona	Referencia	Unidad de empaque
	2901584	10 ud
	2909596	25 ud
	Rainmax	

Soporte canal	Referencia	Unidad de empaque
	2901323	100 ud

Tapa interior derecha	Referencia	Unidad de empaque
	2901329	50 ud

Hidrosello Canal	Referencia	Unidad de empaque
	2001531	1 ud

# CANALES Y BAJANTES

	Referencia	Unidad de empaque
Unión esquina interior		
	2901587	10 ud

	Referencia	Unidad de empaque
Unión esquina exterior		
	2901586	10 ud

	Referencia	Unidad de empaque
Tapa interior izquierda		
	2901330	50 ud

	Referencia	Unidad de empaque
Tapa exterior derecha		
	2901327	50 ud

	Referencia	Unidad de empaque
Tapa exterior izquierda		
	2901328	50 ud

## Canal Raingo

	Referencia	Unidad de empaque
Canal Raingo Tramos de 3 metros Blanca		
	2900117	10 ud

## Conexiones canal Raingo

	Referencia	Unidad de empaque
Tapa externa		
	2901331	100 ud

	Referencia	Unidad de empaque
Tapa interna		
	2901332	100 ud

	Referencia	Unidad de empaque
Unión esquina interior o exterior		
	2901585	20 ud

	Referencia	Unidad de empaque
Unión canal a bajante Raingo		
	2901583	20 ud

	Referencia	Unidad de empaque
Unión canal		
	2901581	50 ud

# CANALES Y BAJANTES

	Referencia	Unidad de empaque
<b>Soporte de canal</b>		
	2901324	100 ud

	Referencia	Unidad de empaque
<b>Hidrosello Canal</b>		
	2000271	1 ud

## Bajantes

### Tradicional y Rainmax

	Referencia	Tipo	Unidad de empaque
<b>Bajante Tramos de 3m extremos lisos blancos</b>			
	2900103	Tradicional	10 ud
	2909554	Rainmax	4 ud

\* Rainmax 100 x 100 m.m.

### Conexiones bajantes

	Referencia	Tipo	Unidad de empaque
<b>Codo de bajante 90°</b>			
	2909593	Rainmax	10 ud
	2901058	Tradicional	25 ud

\*Rainmax 100 x 100 m.m.

	Referencia	Unidad de empaque	
<b>Codo de bajante 45°</b>			
	2909592	Rainmax	25 ud
	2901057	Tradicional	10 ud

\* Rainmax 100 x 100 m.m.

	Referencia	Unidad de empaque	
<b>Soporte de bajante</b>			
	2909594	Rainmax	100 ud
	2901322	Tradicional	50 ud

\* Rainmax 100 x 100 m.m.

	Referencia	Unidad de empaque	
<b>Unión de bajante</b>			
	2909595	Rainmax	50 ud
	2901580	Tradicional	25 ud

\* Rainmax 100 x 100 m.m.

	Referencia	Unidad de empaque
<b>Adaptador bajante 3 y 4</b>		
	2900672 (3")	20 ud
	2900673 (4")	25 ud
	*2909591 (110mmx4")	10 ud

\* Rainmax 100 m.m. x 4"

## Complementarios

### Cinta Sellante

Referencia Diámetro Unidad de  
m.m. empaque

Cinta sellante PREMIUM para roscas	Referencia	Diámetro m.m.	Unidad de empaque
	2908186	12mm x 12m	12 ud
	2908187	18mm x 20m	6 ud
	2909556	18mm x 50m	1 ud
	2909557	24mm x 50m	1 ud

### Diablo Rojo

Referencia Peso Unidad de  
empaque

Frasco 350g	Referencia	Peso	Unidad de empaque
	2905664	Frasco 350g	caja x 12 ud

### Canastilla

Referencia Diámetro Unidad de  
pulg. empaque

Filtro plástico	Referencia	Diámetro pulg.	Unidad de empaque
	2903167	4	50 ud

### Desague sencillo

Desague sencillo	Referencia	Diámetro pulg.	Unidad de empaque
	2903236	1 1/4	80 ud

## COMPLEMENTOS PVC

### Sifones

Referencia Diámetro Unidad de  
pulg. empaque

Sifón botella	Referencia	Diámetro pulg.	Unidad de empaque
	2903289	1 1/2	35 ud

Sifón en "P" con adaptador	Referencia	Diámetro pulg.	Unidad de empaque
	2903290	1 1/2	30 ud

### Acoples

Referencia Largo Unidad de  
de cm empaque

Para lavamanos y lavaplatos 1/2 x 1/2	Referencia	Largo de cm	Unidad de empaque
	2903140	60	50 ud
	*2910493	60	100 ud

Con válvula de regulación 1/2 x 1/2	Referencia	Largo de cm	Unidad de empaque
	2903142	70	30 ud

Acople sanitario 1/2 x 1/8	Referencia	Largo de cm	Unidad de empaque
	2903144	40	50 ud
	*2910494	60	100 ud

Con válvula de regulación doble salida 1/2 x 1/2	Referencia	Largo de cm	Unidad de empaque
	2903141	40	20 ud

Referencia Largo cm Unidad de empaque

Acople sanitario con válvula de regulación $\frac{1}{2} \times \frac{7}{8}$	Referencia	Largo cm	Unidad de empaque
	2903143	40	30 ud

Referencia Diámetro pulg. Unidad de empaque

Perimetral sifonada	Referencia	Diámetro pulg.	Unidad de empaque
	2905693	3 x 2	50 ud

## Rejillas Plásticas

## PISOS

Referencia Diámetro Unidad de empaque

Sifón Anti Cucaracha	Referencia	Diámetro	Unidad de empaque
	2905692	3 x 2	50 ud

Rejilla de piso Estrella	Referencia	Diámetro	Unidad de empaque
	2905701	3 x 2	60 ud

Rejilla de piso Corriente	Referencia	Diámetro	Unidad de empaque
	2905696	3 x 1½	60 ud
	2905697	3 x 2	50 ud
	2906600	4 x 3	40 ud
	2905698	5 x 3	40 ud

Rejilla de piso Anti Cucaracha	Referencia	Diámetro	Unidad de empaque
	2905694	3 x 2	60 ud

Rejilla de piso Diagonal	Referencia	Diámetro	Unidad de empaque
	2905700	3 x 2	60 ud

## Sistemas de rejillas

### Ventilación

Referencia Diámetro cm Unidad de empaque

Rejilla Ventilación Corriente	Referencia	Diámetro cm	Unidad de empaque
	2905702	15 x 15	40 ud
	2905703	20 x 20	20 ud

Rejilla Ventilación Persiana	Referencia	Diámetro cm	Unidad de empaque
	2905706	15 x 15	25 ud
	2905707	20 x 20	15 ud

Rejilla Ventilación Gas	Referencia	Diámetro cm	Unidad de empaque
	2905705	20 x 20	20 ud
	2906601	26 x 26 (ext 30 x 30)	14 ud

## LÍNEA COFLEX

	Referencia	Unidad de empaque	unidad
<b>Tapa Registro</b>			
	2905708	15 x 15	20 ud
	2905709	20 x 20	25 ud

## Accesorios para lavadero

	Referencia	Diámetro pulg.	unidad
<b>Válvula de Pozuelo con Sosco</b>			
	2905710	2½	50 ud

	Referencia	Diámetro pulg.	unidad
<b>Válvula de Pozuelo sin Sosco</b>			
	2905711	2½	50 ud

	Referencia	Diámetro pulg.	unidad
<b>Caja para Llaves de Lavadora</b>			
	2905691	2½	15 ud

## Rejillas

	Referencia	Diámetro pulg.
<b>Rejilla redonda 2" tapa cromada 10x10cm</b>		
	2910954	2
<b>Rejilla redonda 2" en abs gris 10x10cm</b>		
	2910952	2
<b>Rejilla cuadrada 2" en abs gris 10x10cm</b>		
	2910949	2



## Soldamax LOWVOC

	Referencia	Cantidad	Unidad de empaque
			
	2909997	(1/128) Gal	60 ud
	2909999	(1/64) Gal	30 ud
	2909998	(1/32) Gal	30 ud
	2910002	(1/16) Gal	36 ud
	2910001	(1/8) Gal	24 ud
	2910000	(1/4) Gal	12 ud

	Referencia	Cantidad	Unidad de empaque
			
	2909942	(1/128) Gal	60 ud
	2909944	(1/64) Gal	30 ud
	2909943	(1/32) Gal	30 ud
	2909923	(1/16) Gal	36 ud
	2909922	(1/8) Gal	24 ud
	2909921	(1/4) Gal	12 ud

	Referencia	Cantidad	Unidad de empaque
			
	2910003	(1/128) Gal	60 ud
	2910005	(1/8) Gal	24 ud
	2910004	(1/4) Gal	12 ud

## LIMPIAMAX

	Referencia	Cantidad	Unidad de empaque
			
	2902735	28 gr (1/128)	60 ud
	2902738	56 gr (1/64)	30 ud
	2902736	112 gr (1/32)	30 ud
	2902739	300 gr (1/8)	24 ud
	2902737	760 gr (1/4)	12 ud

## CONDUIT - CONDUFLEX - CONDUGAS

Conducción de cables electricos y telefonicos

### Tuberías

	Referencia	Diámetro pulg.	Unidad de empaque
			
	Tubería Para Placa **Alto impacto Tubo: tramo de 3m con campana		
	2900133	½	24 tubos
	2900138	¾	24 tubos
	2900125	1	24 tubos
	2900130	1¼	14 tubos
	2900128	1½	10 tubos
	2900135	2	1 tubo

### Conexiones

	Referencia	Diámetro pulg.	Unidad de empaque
			
	Eléctricos Conduit Curvas 90° C x E		
	2902709	½	200 ud
	2902713	¾	100 ud
	2902702	1	50 ud
	2902706	1¼	50 ud
	2902704	1½	25 ud
	2902711	2	15 ud

Referencia Diámetro Unidad de empaque

	Referencia	Diámetro	Unidad de empaque
			
	Adaptadores terminales campanas		
	2900831	2	100 ud
	2900834	3	25 ud
	2900840	4*	25 ud
	2900841	6	1 ud

\*Conexiones no compatibles con tubería TDP 4".

Referencia Diámetro Unidad de  
pulg. empaque

Referencia Diámetro Unidad de  
pulg. empaque

Uniones			
	2901595	½	500 ud
	2901603	¾	200 ud
	2901590	1	200 ud

Suplemento			
	2901326	107 x 107 mm	200 ud

Cauchos para doblar Largo 1.80m			
	2903170	½	1 ud
	2903171	¾	1 ud
	2903169	1	1 ud

Caja Octagonal			
	2901042	100 x 100 x 47 mm	100 ud

Adaptadores Terminales			
	2900825	½	1.000 ud
	2900836	¾	100 ud
	2900812	1	50 ud
	2900820	1¼	50 ud
	2900816	1½	25 ud
	2900829	2	15 ud
2900833*	3	50 ud	

Caja doble (2400)			
	2901040	107 x 107 x 48 mm	50 ud

\*No incluye tuerca.

Caja sencilla (5800)			
	2901044	103 x 60 x 45 mm	100 ud

## ACUEDUCTO - BIAxIAL

Sistema de tuberías y conexión tipo unión mecánica

### Tuberías

	Referencia	Diámetro o pulg.	Unidad de empaque
Tramos 6m PR-200 PSI Presión de trabajo a 23°C 	2905079	3	1 tubo
	2900109	4	1 tubo
	2900111	6	1 tubo
	2900113	8	1 tubo
	2900105	10	1 tubo
	2900107	12	1 tubo
	2900524	14	1 tubo
	2905388	16	1 tubo
	2905393	18	1 tubo
	2905395	20	1 tubo

	Referencia	Diámetro o pulg.	Unidad de empaque
Tramos 6m PR-160 PSI Presión de trabajo a 23°C 	2905080	3	1 tubo
	2900110	4	1 tubo
	2900112	6	1 tubo
	2900114	8	1 tubo
	2900106	10	1 tubo
	2900108	12	1 tubo
	2900523	14	1 tubo
	2905387	16	1 tubo
	2905392	18	1 tubo
	2905394	20	1 tubo

## UNION PLATINO

Sistema de tuberías y conexión presión tipo unión mecánica

### Tuberías

	Referencia	Diámetro o pulg.	Unidad de empaque
RDE 21-200 PSI Presión de trabajo a 23°C 	2900010	2	1 tubo
	2900022	3	1 tubo
	2900033	4	1 tubo
	2900043	6	1 tubo
	2900054	8	1 tubo
	2902411	10	1 tubo
	2902421	12	1 tubo
	2902431	14	1 tubo
	2902435	16	1 tubo
	2902439	18	1 tubo
	2902443	20	1 tubo
	2904900	24	1 tubo

	Referencia	Diámetro o pulg.	Unidad de empaque
RDE 26 - 160 PSI 	2900012	2	1 tubo
	2900024	3	1 tubo
	2900035	4	1 tubo
	2900045	6	1 tubo
	2900056	8	1 tubo
	2902413	10	1 tubo
	2902423	12	1 tubo
	2902432	14	1 tubo
	2902436	16	1 tubo
	2902440	18	1 tubo
	2902444	20	1 tubo
	2904926	24	1 tubo

	Referencia	Diámetro o pulg.	Unidad de empaque
RDE 32.5 - 125 PSI 	2900026	3	1 tubo
	2900037	4	1 tubo
	2900047	6	1 tubo
	2900058	8	1 tubo
	2902415	10	1 tubo
	2902425	12	1 tubo
	2902433	14	1 tubo
	2902437	16	1 tubo
	2902441	18	1 tubo
	2902492	20	1 tubo
	2906170	24	1 tubo

	Referencia	Diámetro pulg.	Unidad de empaque
	2900039	4	1 tubo
	2900049	6	1 tubo
	2900060	8	1 tubo
	2902417	10	1 tubo
	2902427	12	1 tubo
	2902434	14	1 tubo
	2902438	16	1 tubo
	2902442	18	1 tubo
	2902445	20	1 tubo
	2905412	24	1 tubo

	Referencia	Diámetro pulg.	Unidad de empaque
	<b>Codos Gran radio 6°</b>		
	2902670	8	1 ud
	2902668	10	1 ud
	2902669	12	1 ud

## Conexiones

	Referencia	Diámetro pulg.	Unidad de empaque
	<b>RDE 21-200 PSI Codos Gran radio 90°</b>		
	2902672	10	1 ud
	2902674	12	1 ud

	Referencia	Diámetro pulg.	Unidad de empaque
	<b>Uniones rápidas</b>		
	2902892	2	1 ud
	2902898	3	1 ud
	2902901	4	1 ud
	2902905	6	1 ud
	2902909	8	1 ud
	2902885	10	1 ud
	2902889	12	1 ud

	Referencia	Diámetro pulg.	Unidad de empaque
	<b>Codos Gran radio 45°</b>		
	2902652	10	1 ud
	2902654	12	1 ud

	Referencia	Diámetro pulg.	Unidad de empaque
	<b>Uniones</b>		
	2902894	2	1 ud
	2902900	3	1 ud
	2902904	4	1 ud
	2902907	6	1 ud
	2902912	8	1 ud
	2902887	10	1 ud
	2902891	12	1 ud

	Referencia	Diámetro pulg.	Unidad de empaque
	<b>Codos Gran radio 22½°</b>		
	2902639	2	1 ud
	2902643	3	1 ud
	2902645	4	1 ud
	2902648	6	1 ud
	2902650	8	1 ud
	2902635	10	1 ud
2902637	12	1 ud	

	Referencia	Diámetro pulg.	Unidad de empaque
	<b>Uniones de reparación</b>		
	2902945	2	1 ud
	2902950	3	1 ud
	2902953	4	1 ud
	2902956	6	1 ud
	2902959	8	1 ud
	2902941	10	1 ud
	2902943	12	1 ud

	Referencia	Diámetro pulg.	Unidad de empaque
	<b>Codos Gran radio 11¼°</b>		
	2902622	2	1 ud
	2902626	3	1 ud
	2902628	4	1 ud
	2902631	6	1 ud
	2902633	8	1 ud
	2902618	10	1 ud
	2902620	12	1 ud

	Referencia	Diámetro pulg.	Unidad de empaque
	<b>Collares derivación inserto metálico</b>		
	2904567	2 x ½	50 ud
	2904569	3 x ½	50 ud
	2904570	4 x ½	50 ud
	2904571	6 x ½	50 ud

Referencia Diámetro  
o pulg. Unidad de  
empaque

Collares derivación	Referencia	Diámetro o pulg.	Unidad de empaque
	2901231	2 x ¾	50 ud
	2901239	3 x ¾	50 ud
	2901243	4 x ¾	25 ud
	2901247	6 x ¾	20 ud
	2901248	8 x 1	10 ud

Referencia Peso Unidad de  
empaque

Lubricante (tarro)	Referencia	Peso	Unidad de empaque
	2902743	500 g	50 ud
	2902741	4 kg	50 ud

## Conexiones radio corto

Referencia Diámetro  
o pulg. Unidad de  
empaque

Codos 90°	Referencia	Diámetro o pulg.	Unidad de empaque
	2903528	1½	1 ud
	2908617*	2	1 ud
	2909095*	3	1 ud
	2909096*	4	1 ud
	2909097*	6	1 ud
	2903463	8	1 ud

\*Inyectado nacional.

Codos 45°

Codos 45°	Referencia	Diámetro o pulg.	Unidad de empaque
	2908616*	2	1 ud
	2909092*	3	1 ud
	2909093*	4	1 ud
	2909094*	6	1 ud
	2903467	8	1 ud

\*Inyectado nacional.

Referencia Diámetro  
o pulg. Unidad de  
empaque

Reducciones	Referencia	Diámetro o pulg.	Unidad de empaque
	2903549	2 x 1½	1 ud
	2903547	3 x 2	1 ud
	2903545	4 x 2	1 ud
	2908618*	4 x 3	1 ud
	2908619*	6 x 4	1 ud
	2903471	8 x 6	1 ud

\*Inyectado nacional.

## Acometidas Domiciliarias PF+UAD

Referencia Diámetro Unidad de  
pulg. empaque

Rollos 90m RDE 9 Presión 160 PSI Tamaño cobre	Referencia	Diámetro pulg.	Unidad de empaque
	2900301	½	90m
	2900302	¾	90m

\*Inyectado nacional.

## Conexiones PF+UAD

Referencia Diámetro  
o pulg. Unidad de  
empaque

Adaptador macho	Referencia	Diámetro o pulg.	Unidad de empaque
	2900755	½	40 ud
	2903146	¾	40 ud

Adaptador hembra

Adaptador hembra	Referencia	Diámetro o pulg.	Unidad de empaque
	2900691	½	50 ud

Referencia Diámetro mm-pulg. Unidad de empaque

Unión			
	2901609	½	50 ud
	2903379	¾	50 ud

Codo 90°			
	2901060	½	50 ud

## ALCANTARILLADO - NOVAFORT

Sistema de tuberías y conexión  
Alcantarillado hermético

### Tuberías

Referencia Diámetro mm-pulg. Unidad de empaque

Tuberías alcantarillado Novafort tramos 6m			
	2900090	110 mm	1 tubo
	2900092	160 mm	1 tubo
	2900094	200 mm	1 tubo
	2900081	250 mm	1 tubo
	2900083	315 mm	1 tubo
	2902493	355 mm	1 tubo
	2900085	400 mm	1 tubo
	2900087	450 mm	1 tubo
	2900089	500 mm	1 tubo

Tuberías Novafort Tramos 6.5m			
	2906313	24"	1 tubo
	2900511	27"	1 tubo
	2906378	30"	1 tubo
	2904604	33"	1 tubo
	2904605	36"	1 tubo
	2905865	39"	1 tubo
	2905866	42"	1 tubo
	2910888	45"	1 tubo
	2910889	48"	1 tubo

Referencia Diámetro mm-pulg. Unidad de empaque

Tuberías S4 Tramos 6m			
	2900100	160 mm	1 tubo
	2900102	200 mm	1 tubo
	2900096	250 mm	1 tubo
	2904921	315 mm	1 tubo
	2902494	355 mm	1 tubo
	2909762	400 mm	1 tubo

### Conexiones

Referencia Diámetro mm-pulg. Unidad de empaque

Uniones			
	2901576	110	1 ud
	2901577	160	1 ud
	2907997	200	1 ud
	2902914	250	1 ud
	2902917	315	1 ud
	2910937	355	1 ud
	2902921	400	1 ud
	2902924	450	1 ud
	2902926	500	1 ud
	2906753	24"	1 ud
	2900517	27"	1 ud
	2900518	30"	1 ud
	2906333	33"	1 ud
	2907224	36"	1 ud
	2907225	39"	1 ud
	2907299	42"	1 ud
	2911972	45"	1 ud

### Codos 90°

	2901051	110	1 ud
	2901052	160	1 ud

### Codos 45°

	2901045	110	1 ud
	2901046	160	1 ud

Referencia Diámetro  
o m.m. Unidad de  
empaque

Referencia Diámetro  
m.m. Unidad de  
empaque

Tees			
	2901445	160 x 160	1 ud
	2901526	200 x 160	1 ud
	2902826	250 x 160	1 ud

Yees			
	2901709	160 x 160	1 ud
	2907351	200 x 160	1 ud
	2902962	250 x 160	1 ud
	2902963	315 x 160	1 ud
	2902964	400 x 160	1 ud

Kit silla yee			
	2901269	160 x 110	1 ud
	2901270	200 x 110	1 ud
	2901271	200 x 160	1 ud
	2901272	250 x 110	1 ud
	2901273	250 x 160	1 ud
	2902733	315 x 110	1 ud
	2907849	315 x 160	1 ud

Kit silla yee S4 Plus			
	2901794	200 x 160	1 ud
	2901785	250 x 160	1 ud
	2907850	315 x 160	1 ud

Kit silla tee			
	2901264	160 x 110	1 ud
	2901265	200 x 110	1 ud
	2901266	200 x 160	1 ud
	2901267	250 x 110	1 ud
	2901268	250 x 160	1 ud
	2902731	315 x 110	1 ud
	2902732	315 x 160	1 ud

Sillas tee*			
	2901295	160 x 110	1 ud
	2903085	160 x 160	1 ud
	2901297	200 x 110	1 ud
	2901299	200 x 160	1 ud
	2901301	250 x 110	1 ud
	2901303	250 x 160	1 ud
	2903093	250 x 200	1 ud
	2902766	315 x 110	1 ud
	2902768	315 x 160	1 ud
	2903094	315 x 200	1 ud
	2903095	315 x 250	1 ud
	2902984	355 x 110	1 ud
	2902981	355 x 160	1 ud
	2903111	355 x 200	1 ud
	2902770	400 x 110	1 ud
	2902772	400 x 160	1 ud
	2903096	400 x 200	1 ud
	2903097	400 x 250	1 ud
	2902774	450 x 160	1 ud
	2902775	500 x 160	1 ud
	2902985	24 x 160	1 ud
	2902986	24 x 200	1 ud
	2905671	27 x 315	1 ud

Sillas yee*			
	2901309	160 x 110	1 ud
	2901311	200 x 110	1 ud
	2901313	200 x 160	1 ud
	2901315	250 x 110	1 ud
	2901317	250 x 160	1 ud
	2903113	250 x 200	1 ud
	2902777	315 x 110	1 ud
	2907844	315 x 160	1 ud
	2902978	315 x 200	1 ud
	2902983	355 x 110	1 ud
	2902982	355 x 160	1 ud
	2902979	355 x 200	1 ud
	2902781	400 x 110	1 ud
	2907845	400 x 160	1 ud
	2902785	400 x 200	1 ud
	2902776	400 x 250	1 ud
	2902787	450 x 160	1 ud
	2902980	450 x 200	1 ud
	2902789	500 x 160	1 ud
	2902990	500 x 200	1 ud
	2903112	24 x 160	1 ud
	2902977	24 x 200	1 ud
	2903107	27 x 160	1 ud
	2902987	27 x 200	1 ud
	2903059	27 x 250	1 ud
	2906134	30 x 160	1 ud
	2906474	30 x 200	1 ud
	2906159	33 x 160	1 ud
	2906135	36 x 160	1 ud

\*Para instalación con adhesivo epóxico.

Referencia Diámetro  
o m.m. Unidad de  
empaque

Hidrosellos Novafort	Referencia	Diámetro o m.m.	Unidad de empaque
	2000281	110 mm S8	1 ud
	2000282	160 mm S8 Y S4	1 ud
	2000283	200 mm S8 Y S4	1 ud
	2000284	250 mm S8	1 ud
	2000390	250 mm S4	1 ud
	2000285	315 mm S8 Y S4	1 ud
	2000386	355 mm S8 Y S4	1 ud
	2000286	400 mm S8	1 ud
	2000391	400 mm S4	1 ud
	2000287	450 mm S8	1 ud
	2000288	500 mm S8	1 ud
	2000845	24" S4	1 ud
	2000358	27" S4	1 ud
	2000850	30" S4	1 ud
	2000541	33	1 ud
	2000542	36	1 ud
	2000734	39	1 ud
	2000751	42	1 ud

Referencia Diámetro  
o mm-pulg. Unidad de  
empaque

Codo 45°	Referencia	Diámetro o mm-pulg.	Unidad de empaque
	2902687	200 mm	1 ud
	2902688	250 mm	1 ud
	2903071	315 mm	1 ud

Conector Novafort Concreto	Referencia	Diámetro o mm-pulg.	Unidad de empaque
	2902606	200 x 8"	1 ud
	2903070	160 x 6"	1 ud

## Conexiones fabricadas

Referencia Diámetro  
mm-pulg. Unidad de  
empaque

Adaptador Novafort Sanitaria	Referencia	Diámetro mm-pulg.	Unidad de empaque
	2902965	110 x 4"sanit	1 ud
	2902604	160 x 6" sanit	1 ud
	2902605	200 x 6"sanit	1 ud
	2904914	200 x 8"sanit	1 ud
	2904915	250 x 10"sanit	1 ud

Codo 90°	Referencia	Diámetro mm-pulg.	Unidad de empaque
	2902689	200 mm	1 ud
	2902690	250 mm	1 ud
	2902691	315 mm	1 ud
	2903061	355 mm	1 ud
	2902692	400 mm	1 ud
	2902693	450 mm	1 ud
	2902723	500 mm	1 ud

Tee	Referencia	Diámetro mm-pulg.	Unidad de empaque
	2902825	200 mm	1 ud
	2902820	250 mm	1 ud
	2903108	250 x 200	1 ud
	2902821	315 mm	1 ud
	2903110	315 x 200	1 ud
	2903062	355 mm	1 ud
	2902822	400 mm	1 ud
	2902823	450 mm	1 ud
2906089	500 mm	1 ud	

Tee doble	Referencia	Diámetro mm-pulg.	Unidad de empaque
	2903109	315 x 160	1 ud

Referencia Diámetro  
o m.m. Unidad de  
empaque

Base Caja de Inspección 315	Referencia	Diámetro o m.m.	Unidad de empaque
	2901845	160 x 110	1 ud



# HIERRO

- Acero 26
- Alambres y Mallas 27

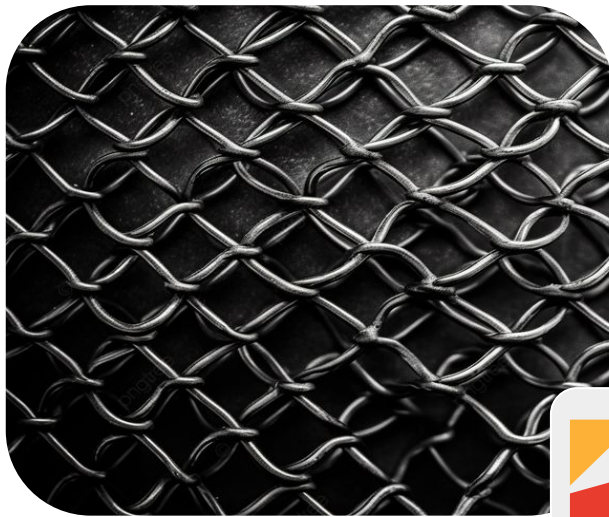



## VARILLAS CORRUGADAS

DIÁMETRO	CANTIDAD	PESO (KG)
VARILLA CORR. 7MM (1/4) N°2	670	1,49
VARILLA CORR 8,5 MM	373	2,68
VARILLA CORR 9 MM	333	3,00
VARILLA CORR 9,5 MM (3/8)N°3	298	3,36
VARILLA CORR 10 MM	280	3,57
VARILLA CORR 11 MM	223	4,48
VARILLA CORR 12 MM	188	5,32
VARILLA CORR 1/2"N°4	168	5,95
VARILLA CORR 5/8"N°5	107	9,35
VARILLA CORR 3/4"N°6	75	13,33
VARILLA CORR 7/8"N°7	55	18,18
VARILLA CORR 1"N° 8	42	23,81



## VARILLAS LISAS

DIÁMETRO	CANTIDAD/TON	PESO (KG)
VARILLAS LISAS 1"	42	23,86
VARILLAS LISAS 1/2"	168	5,96
VARILLAS LISAS 3/4"	75	13,42
VARILLAS LISAS 5/8"	108	9,33
VARILLAS LISAS 7/8"	55	18,26



## KILO HIERRO

KILO HIERRO 1/2
KILO HIERRO 1/4
KILO HIERRO 3/8
KILO HIERRO 9



**KILO HIERRO FIGURADO**

KILO HIERRO FIGURADO FLEJES 1/2

KILO HIERRO FIGURADO FLEJES 1/4

KILO HIERRO FIGURADO FLEJES 3/8

KILO HIERRO FIGURADO FLEJES 9



# ALAMBRE GALVANIZADO

## KILO ALAMBRE GALVANIZADO / (NEGRO)

KILO ALAMBRE GALVANIZADO # 10

KILO ALAMBRE GALVANIZADO # 12

KILO ALAMBRE GALVANIZADO # 12 OPACO

KILO ALAMBRE GALVANIZADO # 14

KILO ALAMBRE GALVANIZADO # 16

KILO ALAMBRE GALVANIZADO # 18

KILO ALAMBRE GALVANIZADO # 8

KILO ALAMBRE NEGRO



**ALAMBRE d/seg CONCERTINA  
RLL X4.9 K**

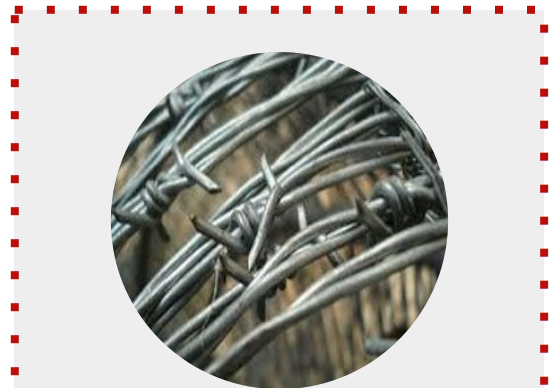

**ALAMBRE DE PÚAS**

**MALLA ELECTROSOLDADA**

DIÁMETRO	CANTIDAD	PESO (KG)
ROLLO MALLA EL. 2.35 X 6MTS 3 MM	200	31,59
MALLA EL. 2.35 X 6MTS 4 MM	50	18,8
MALLA EL. 2.35 X 6MTS 5 MM	50	29,3
MALLA EL. 2.35 X 6MTS 5,5 MM	50	35,5
MALLA EL. 2.35 X 6MTS 6 MM	35	42,2
MALLA EL. 2.35 X 6MTS 7 MM	30	57,4
MALLA EL. 2.35 X 6MTS 7,55 MM	25	65,9
MALLA EL. 2.35 X 6MTS 8 MM	20	75,1

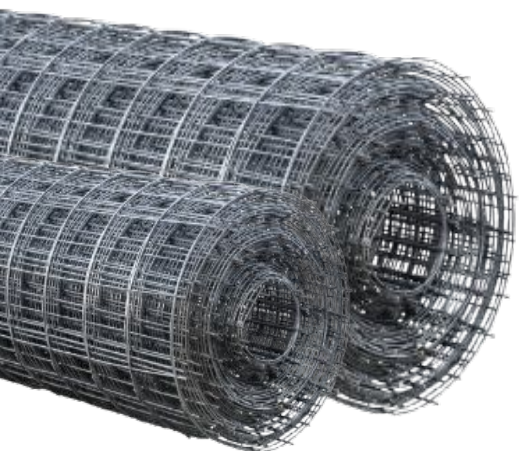

**MALLAS**

MALLA 1 X 1.80 MTS. MT.

MALLA 1.1/4 X 1.80 MT. MT.

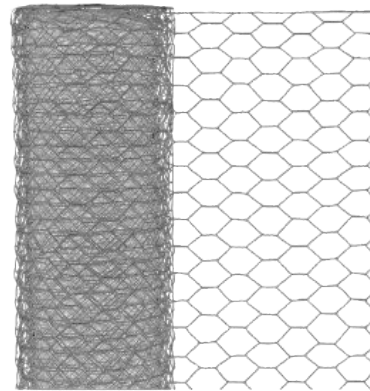
**ESLABONADA**

ROLLO MALLA ESLAB. 2.1/2X2 C-10.5X10 MT

ROLLO MALLA ESLAB. 2.1/2X2 C-10.5 X 20MT

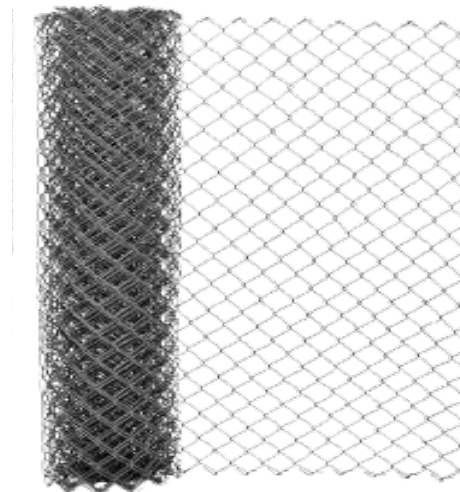

**GAVIÓN**

GAVIÓN TIPO A 2X1X1 C-12

GAVIÓN TIPO A 2X1X1 C-13

GAVIÓN TIPO C 2X1X1 C-13

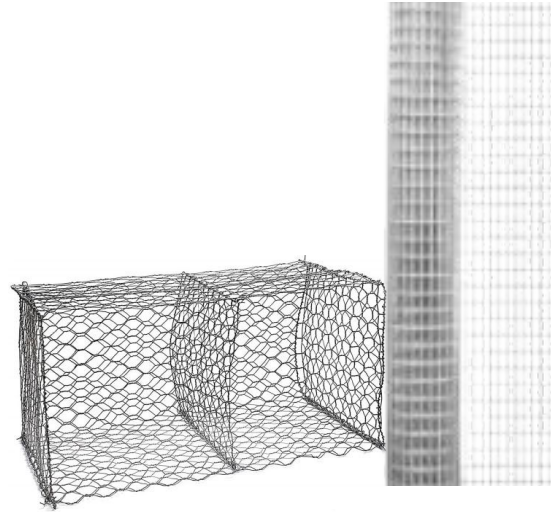
**MALLA CON VENA 2X50**

MALLA CON VENA 2X50

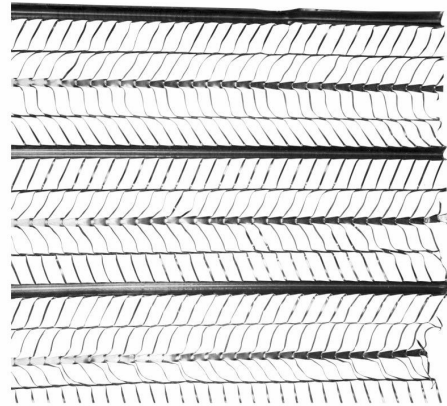
**COMPLEMENTOS** □



# PERFILES

- Tubo Mueble 58
- Placa Facil - Tubo Cerram 57
- Ángulos 59
- Perfil en C Canal Paral 62



## TUBO MUEBLE

### CUADRADO

TUBO MUEBLE CUAD. 1 X 0.80 MM(c-20)
TUBO MUEBLE CUAD. 1 X 1 MM(c-18)
TUBO MUEBLE CUAD. 1 X 1.10 MM(c-18)
TUBO MUEBLE CUAD. 1.1/2 X 0.80 MM(c-20)
TUBO MUEBLE CUAD. 1.1/2 X 1 MM(c-18)
TUBO MUEBLE CUAD. 1/2 X 0.80 MM(c-20)
TUBO MUEBLE CUAD. 3/4 X 0.80 MM(c-20)
TUBO MUEBLE CUAD. 3/4 X 1MM(c-18)



### RECTANGULAR

TUBO MUEBLE ESTRUCT. RECT. NEGRO 4X1.1/2
TUBO MUEBLE RECT. 2X1 0.80 MM(c-20)
TUBO MUEBLE RECT. 2X1 1 MM(c-18)
TUBO MUEBLE RECT. 2X1 1.10 MM(c-18)
TUBO MUEBLE RECT. 3X1.1/2 0.80 MM(c-20)
TUBO MUEBLE RECT. 3X1.1/2 1 MM
TUBO MUEBLE RECT. 3X1.1/2 1.10 MM(c-18)
TUBO MUEBLE RECT. 3X1.1/2 1.5 MM(c-16)
TUBO MUEBLE RECT. 3X1.1/2 X 0.90 MM



## PLACA FACIL

### NEGRO

PERFIL X 6MT. 130X90MM NEGRO PLACA FACIL

PERFIL X 7MT. 130X90MM NEGRO PLACA FACIL

PERFIL X 9MT. 130X90MM NEGRO PLACA FACIL

PERFIL X10MT. 130X90MM NEGRO PLACA FACIL

PERFIL X12MT. 130X90MM NEGRO PLACA FACIL

PERFIL X7.5MT 130X90MM NEGRO PLACA FACIL



## TUBO CERRAMIENTO

### NEGRO

TUBO CERRAM RED NEGRO 11.5 MM 0.059

TUBO CERRAM RED NEGRO 11.9 MM 0.075

TUBO CERRAM RED NEGRO 1.1/2 1.5 MM 0.059

TUBO CERRAM RED NEGRO 1.1/2 1.9 MM 0.075

TUBO CERRAM RED NEGRO 1.1/4 1.5 MM 0.059

TUBO CERRAM RED NEGRO 1/2 1.5 MM 0.059

TUBO CERRAM RED NEGRO 1/2 1.9 MM 0.075

TUBO CERRAM RED NEGRO 2 1.5 MM 0.059

TUBO CERRAM RED NEGRO 2 1.9 MM 0.075

TUBO CERRAM RED NEGRO 3 1.9 MM 0.075

TUBO CERRAM RED NEGRO 3/4 1.5 MM 0.059

TUBO CERRAM RED NEGRO 3/4 1.9 MM 0.075



## ÁNGULOS

ANGULO 1 X 1/8 (25X2.5MM)

ANGULO 1 X 3/16

ANGULO 1.1/2 X 1/8

ANGULO 1.1/2 X 3/16

ANGULO 1.1/4 X 1/8

ANGULO 2 X 3/16

ANGULO 3/4 X 1/8 (19X2.5MM)

ANGULO ALUM PINT BLANCA 17 MM



## DILATACIÓN

DILATACION ALUMINIO PLATA PULI 10MMX2.5M

DILATACION ALUMINIO PLATA PULI 20MMX2.5M



## PLATINAS

PLATINA 1.1/2 X 3/16

PLATINA 1.1/2X1/4

PLATINA 1.1/2X1/8

PLATINA 1X1/8

PLATINA 1X3/16

PLATINA 2.1/2X3/16

PLATINA 2X1/8

PLATINA 2X3/16

PLATINA 3/16X3

PLATINA 3X1/4

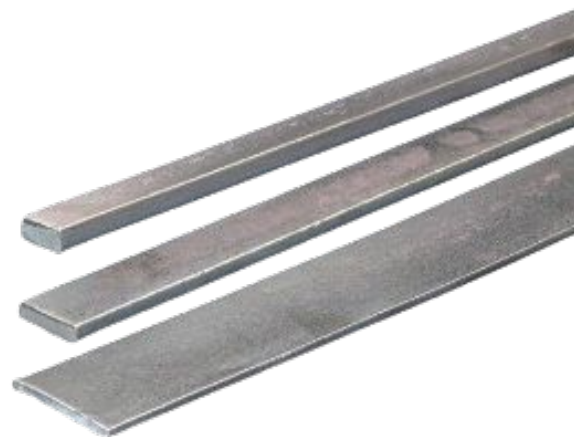

## WING

WING ESPAÑOL MOLDURA, BLANCO

WING TRADIC. (PERFIL) ALUMINIO X 6 MT.

WING TRADIC. (PERFIL) BEIGE X 2.40 MT.

WING TRADIC. (PERFIL) BLANCO X 2.40 MT.



\*Imagen de Referencia

## ÁNGULO CUELGA

ANGULO DE CUELGA 1.1/4X3/4

ANGULO DE CUELGA 1X1

ANGULO DE CUELGA 20X20



## DILATACIÓN

DILATACION PLAST. PERFOR BCA ANGOS TX2MT



## PIRLANES

PIRLAN PLAST. BEIGE X 2 MT.

PIRLAN PLAST. BLANCO X 2 MT.



**PIRLAN DE ESCALERA**

PIRLAN ESCALERA X 6 MT SOLIDO DORADO BTE

PIRLAN ESCALERA X 6 MT. SOLIDO CRUDO

**OMEGA CON BORDE**

OMEGA CON REBORDE

**VIGUETA**

VIGUETA



## PARAL BASE

PARAL BASE 6 (PERFIL C)

PARAL BASE 9 3 5/8X1.1/4

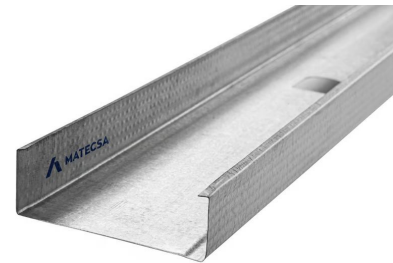

## CANAL BASE

CANAL BASE 6 (PERFIL U)

CANAL BASE 9 3 5/8X1



## PERFIL EN C

PERFIL C 120X60 1.2 MM X 6 MTL. NEGRO

PERFIL C 120X60 1.9 MM X 6 MTL. NEGRO

PERFIL C 220X80 1.5 MM X 6 MTL. NEGRO

PERFIL C 220X80 1.9 MM X 6 MTL. NEGRO

PERFIL C 220X80 2.5 MM X 6 MTL.

PERFIL C 305X80 2 MM X 6 MTL.





# GRES

- Bloques 41
- Tejas de Barra 44
- Fachaleta 45
- Enchape 48
- Guardaescoba - Zocalo 50
- Escalgres 51
- Decorados 52



**BLOQUES**

**BLOQUELON SANTAFE  
80X23X8**

**LADRILLOS**

**LADRILLO H10 COCIDO  
LISO-RÚSTICO**

**LADRILLO H10 MEDIO**

**LADRILLO H7 COCIDO**

**LADRILLO H12 COCIDO**

**LADRILLO H12 MEDIO**

**LADRILLO H15 COCIDO**



**LADRILLO TEMOSA T1 GRES**

**LADRILLO T1  
CÚCUTA 25 X 12 X 6**



**LADRILLO  
MULTIPERFORADO**  
25x12x6 - 2.3kg

**LADRILLO T1  
ESTRUCTURAL 10 X  
12 X 29**

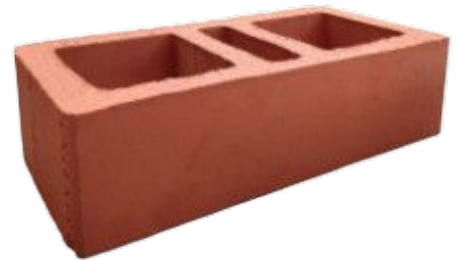

**LADRILLO TEMOSA  
33 X 16 X 7**



**GOBI 8X14 MT**



**LADRILLO BISELADO  
8X25 MTL**



**CALADO ESTRELLA  
20X20**

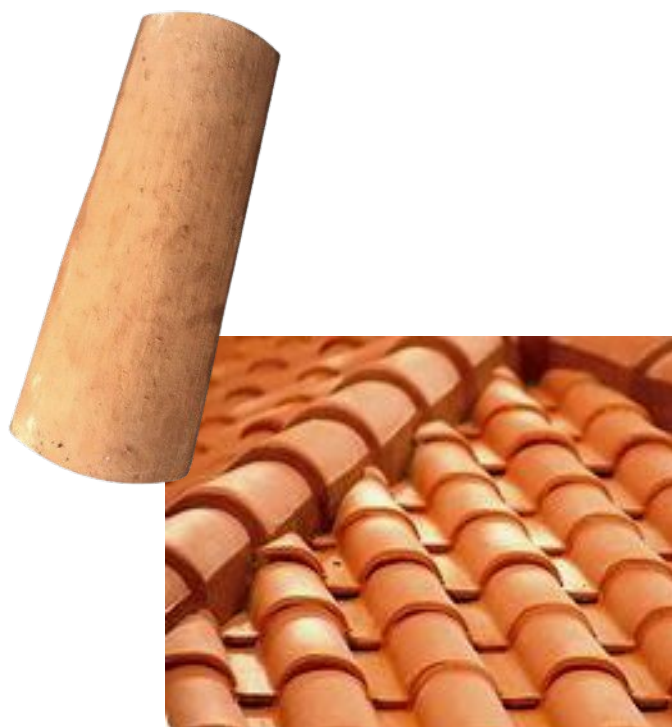
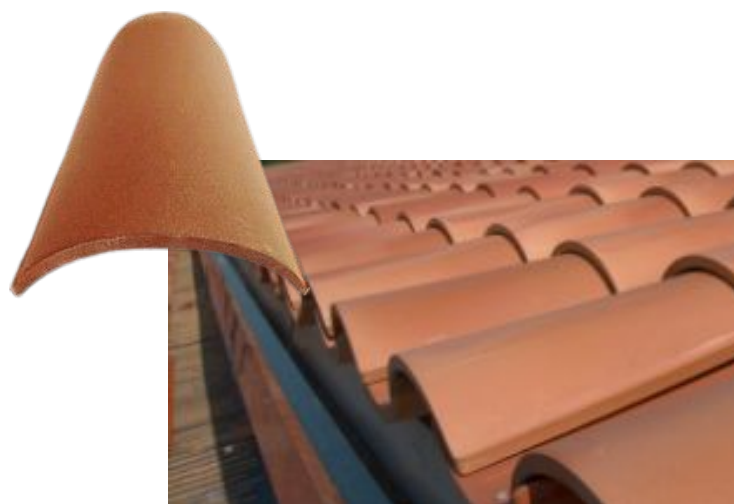

**TEJAS DE BARRA****LADRILLO ESPAÑOL  
PEQUEÑO****LADRILLO ESPAÑOL  
GRANDE****LADRILLO ESPAÑOL  
GRANDE LYA****PRENSADO****LADRILLO T  
PRENSADO  
PEQUEÑO**

**FACHALETA**

**ESPACATO - CASA BLANCA -  
PESCADERO**



**DIMENSIÓN**



**DIMENSION**  
15x15x7 cm



**ESTORAQUE**



**TABLILLA**



**CORCHO 12.5x12.5**

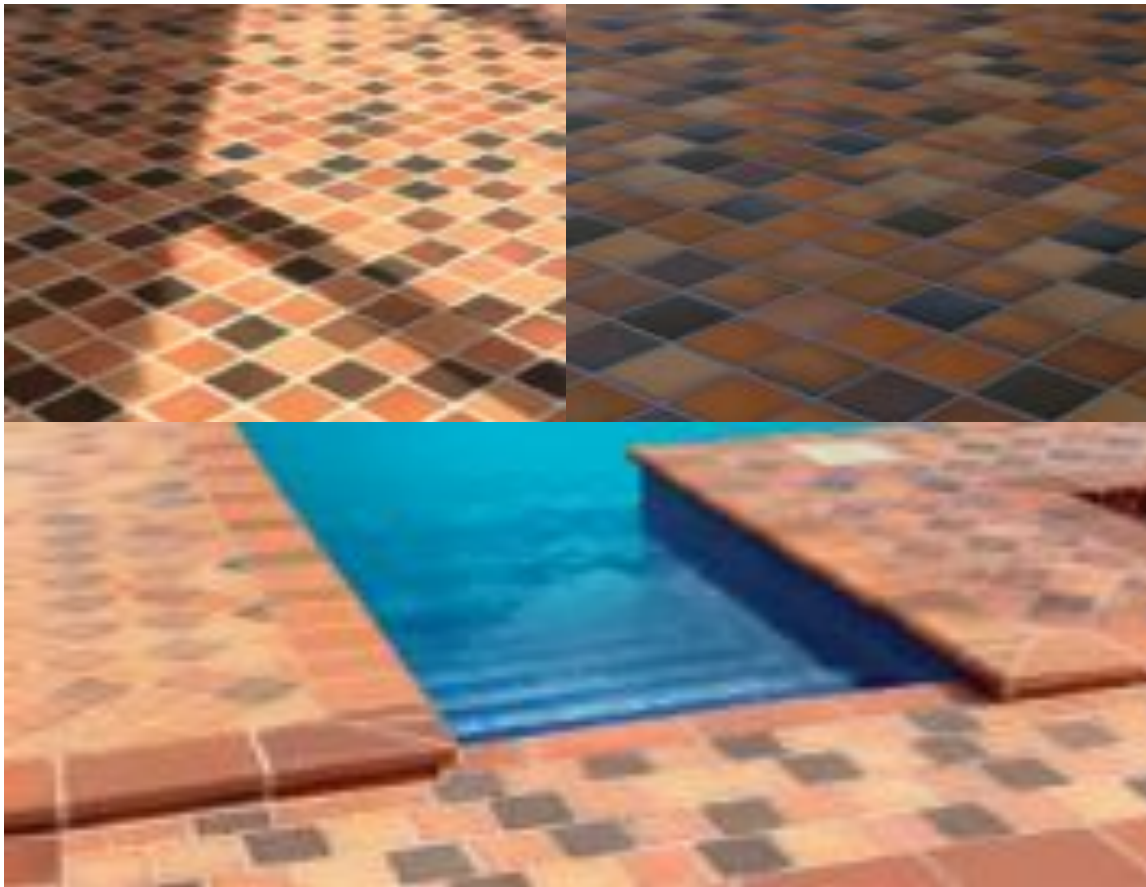



**ENCHAPES - CASA  
BLANCA 30 X 30**



**ENCHAPES - PESCADERO**  
**30 X 30**



**MATIZADO**

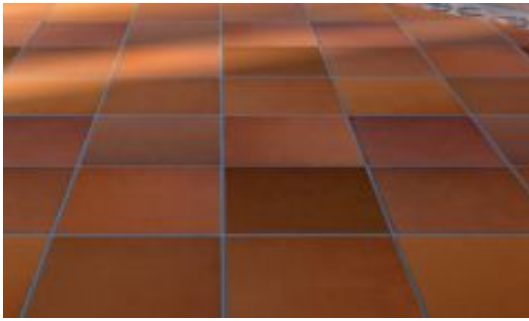

**ALMENDRO**



**TABACO**



**ARENA**



## GUARDA ESCOBA - ZOCALO GRES

### GUARDAESCOBA - ZÓCALO - PESCADERO 30 X 10



#### ARENA



#### ALMENDRO



#### MATIZADA

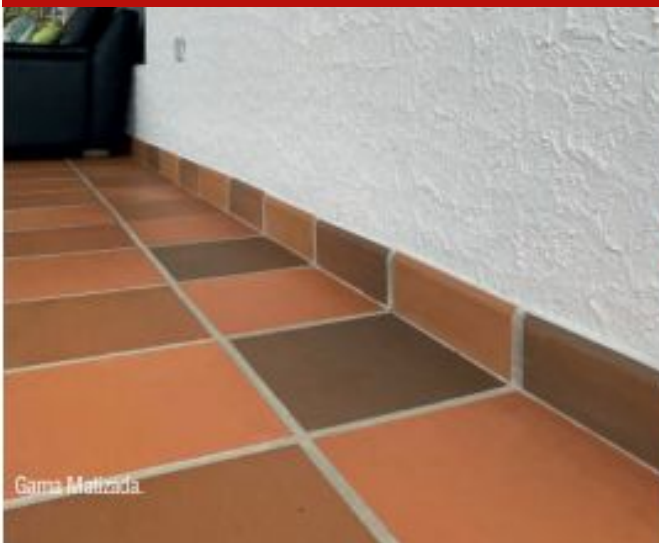

#### TABACO

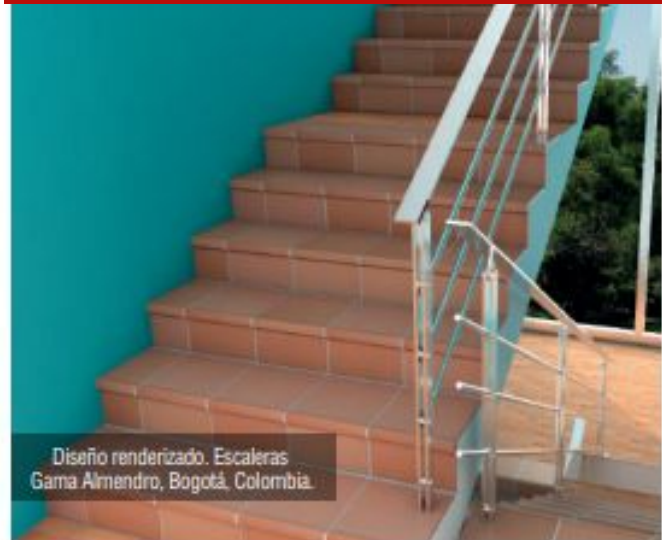

**ESCALGRES - 30 X 30 -  
PESCADERO**
**ARENA****ALMENDRO****MATIZADA****TABACO**

**MALLA ANDALUZ 30X30****MALLA ANDALUZ ALT B****MALLA CELTA ALT A 30X30****MALLA KALOS 27X21 UND  
PESCADERO****MALLA ESTRELLA 30X30  
PESCADERO****MALLA LYRA 30X27 PESCADERO**

**MALLA PRISMA 30X30 PESCADERO****CENEFA ADES 14X28****MOSAICO APOLO 25X25****CENEFA BACO 10X32****MOSAICO BACO 25X25****CENEFA VENUS 11X33**



**ROSETONES - PESCADERO - CASA BLANCA**



  
casablanca

**AFRODITA 65x65cm**



  
casablanca

**BACO 60x60cm**



  
casablanca

**ZEUS 65x65cm**

**VERSALLES 60 X 60**



  
PESCADERO



## TAPETES - PESCADERO - CASA BLANCA



casablanca

**BACO 50x50cm**

## TAPETE CRETA A 60 X 60

A



## TAPETE CRETA B 60 X 60

B



## CEMENTOS

- Bultos 59
- Lavaderos Enchapados 61
- Lavaderos de Granito 62
- Complementos 445

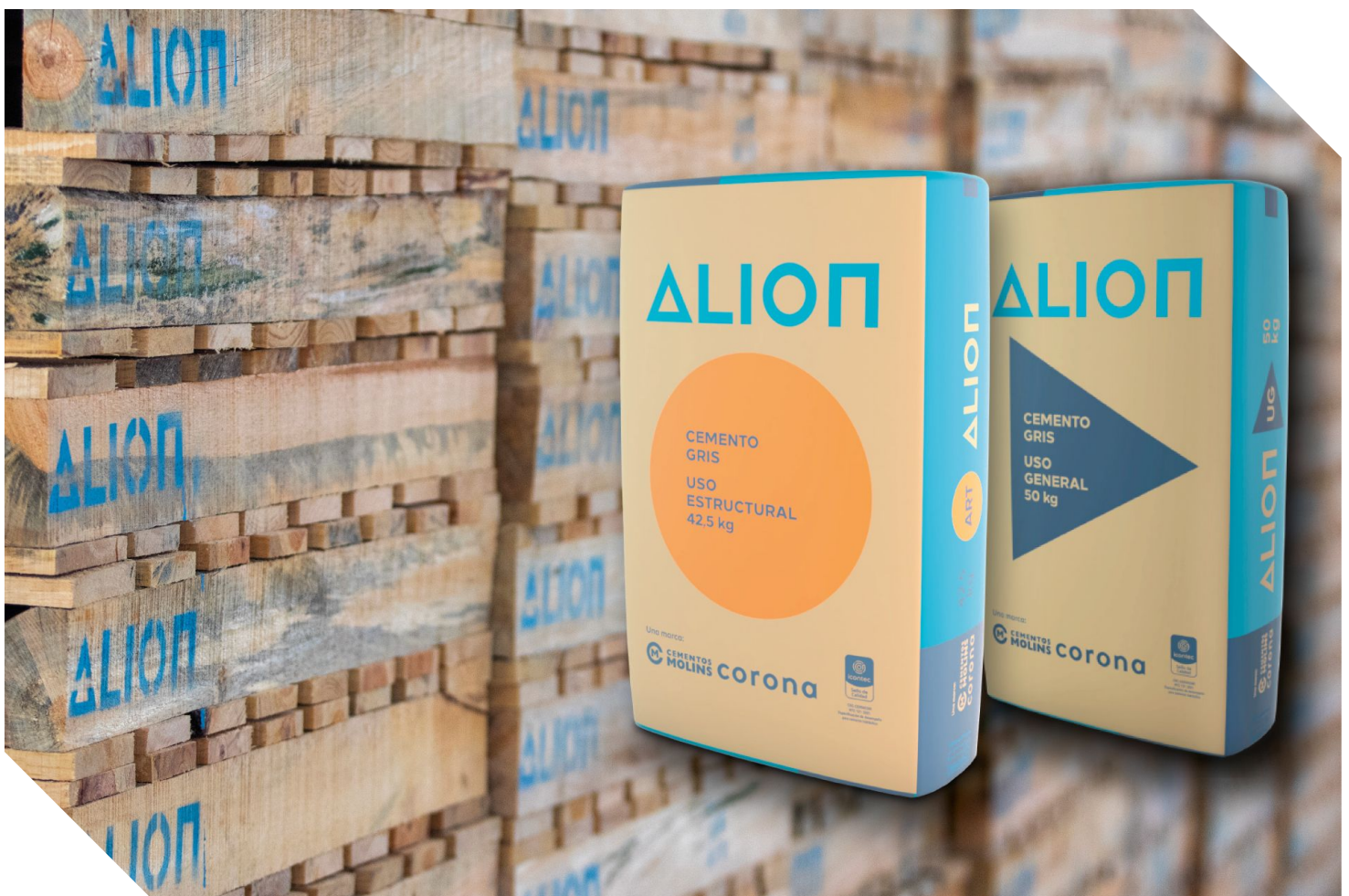

**BULTOS****Bulto de Cemento Gris Alion Corona (25 kg)****Peso**

**Bulto de  
Cemento Gris  
Alion Corona (25  
kg):**

**25 kg****Bulto de Cemento Gris Alion Corona (50 kg)****Peso**

**Bulto de Cemento  
Gris Alion Corona  
(50 kg)**

**50 kg**

## BULTOS

### Bulto de Cemento Blanco Argos Tipo 1 (20 kg)

**Peso**

**Bulto de  
Cemento Blanco  
Argos Tipo 1 (20  
kg)**

**25 kg**



### Bulto de Cemento Blanco Argos Tipo 1 (40 kg)

**Peso**

**Bulto de Cemento  
Blanco Argos  
Tipo 1 (40 kg)**

**40 kg**



### Bulto de Cemento ART Alion Corona (42.5 kg)

**Peso**

**Bulto de Cemento  
ART Alion Corona  
(42.5 kg)**

**42.5 kg**



**LAVADEROS ENCHAPADOS**

- LAVADERO ENCHAPADO 1 X 60
- LAVADERO ENCHAPADO 60 X 60
- LAVADERO ENCHAPADO 70 X 60
- LAVADERO ENCHAPADO 80 X 60
- LAVADERO ENCHAPADO 90 X 60

**LAVADEROS DE GRANITO**

- LAVADERO GRANITO 1 X 60
- LAVADERO GRANITO 60 X 60
- LAVADERO GRANITO 70 X 60
- LAVADERO GRANITO 80 X 60
- LAVADERO GRANITO 90 X 60

## CERAMICAS

- Base Decorada 70
- Combo Baños 77
- Decorados 80
- Fachada 87
- Sanitarios 180
- Lavamanos 93
- Listello 104
- Mosaico - muebles - malla 135
- Pared 145
- Piso 158





**ACRUX GRIS 61X61 1A MT.  
CASTELLON (2.2)**



**ADIGIO 58.4X118.4 1A MT (2.07)**



**AGATA 45X90 1A MT.(1.62)**

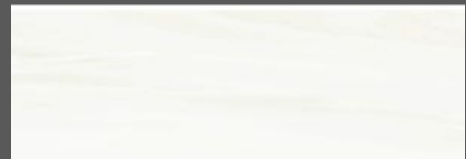

**AMBLER NIEVE 25X75 1A MT. (1.50)**



**AMBROSIO 58.4 X 118.4 1A MT (2.07)**



**ANTAR CREMA BRILLANTE 25X75 1A  
MT.(1.5)**





**ANTAR GRAFITO BRILLANTE 25X75  
1A MT(1.5)**



**ANTARES BEIGE 61X61 1A MT  
CASTELLON(2.2)**



**ANTARES GRIS 61X61 1A MT.  
CASTELLON(2.2)**



**ARCHI CENIZO 60X60 1A MT. (1.80)**



**ARCHI TERRA 60X60 1A MT. (1.80)**

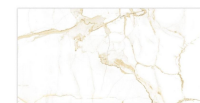

**ANTAR CREMA BRILLANTE 25X75 1A  
MT.(1.5)**

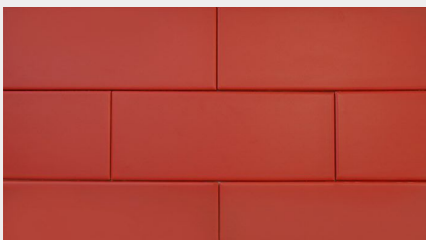
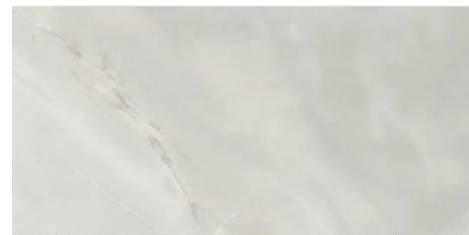
**ARNO NATURE 25X75 1A MT. (1.50)****ASAKY HUMO 60X60 1A MT. (1.80)****ASTERION 30X60 1A MT.(1.62)****BALDOSIN AMARILLO HEXAGONO  
L20 20X20 MT****BALDOSIN LISTON ROJO 30X30 1A MT****BARGELLO MATE 58.4X 118.4 1A MT  
(2.07)**



**BARLOVENTO CARIBEAN ADZ 14.5X14.5  
ACQUA**



**BASE DECOR COFFEE BREAK  
MULTICOLOR 30X60**



**BASE DECORA CIENFUEGOS ORNAM  
MULTI 30X75**



**BASE DECORADA ALTADENA  
NEGRO 30X60**



**BASE DECORADA BAÑO CE-38 25X50**

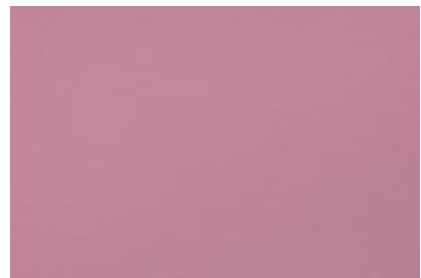

**BASE DECORADA BAÑO MALVA 25X50**



**BASE DECORADA BROOKLYN  
NEGRO 30X60**



**BASE DECORADA CHIPRE TAUPE 20X60**



**BASE DECORADA COCINA FRUTAS  
6198 B 30X60**



**BASE DECORADA COCINA FRUTAS  
6205 B 20X60**



**BASE DECORADA CONGA  
MULTICOLOR 30X60 HOL**



**BASE DECORADA DALIA BEIGE 30X90**



**BASE DECORADA DALIA NEGRO  
PJ36313V 30X60**



**BASE DECORADA DINASTIA  
MULTICOLOR 30X60**

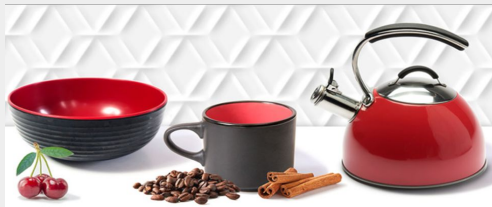

**BASE DECORADA ENCANTO  
ROJO 16X56**

**BASE DECORADA ENCANTO  
VERDE 16X56**

**BASE DECORADA FLOR DE LUNA  
NEGRA 30X60**

**BASE DECORADA GOURMET  
MULTICOLOR 30X60**



**BASE DECORADA INDI TRIANGULO  
CAFE 30X60**



**BASE DECORADA MARMÍ  
MULTICOLOR 30X75**



**BASE DECORADA MAROCO  
MULTICOLOR 30X60**



**BASE DECORADA PANDORA  
MULTICOLOR 20X60**



**BASE DECORADA PLATINO MULTI  
30X60 HOLLI**

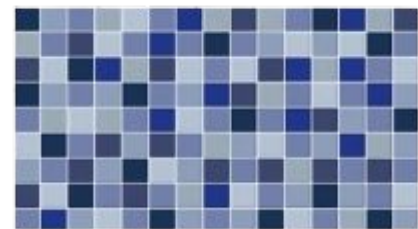

**BASE DECORADA PLAYA CRISTAL  
AZUL 25X43**



**BASE DECORADA PRALINE  
MULTICOLOR 30X60**

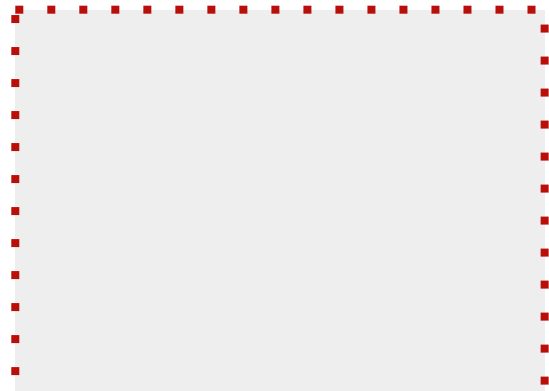

**BASE DECORADA PROVIDENCIA  
MULTI 30X60**



**BASE DECORADA TEA TIME  
MULTICOLOR 30X60**



**BASE DECORADA VERANO 30X60**



**BORDE PISCINA AZUL 2X20**



**BRICK BLANCO 9X27 UND**



**BRITTOLI HUMO 25X75 1A MT. (1.50)**



**BRITTOLI TERRA 25X75 1A MT. (1.50)**



**CANDIA BEIGE 30X60 1A MT. (1.62)**

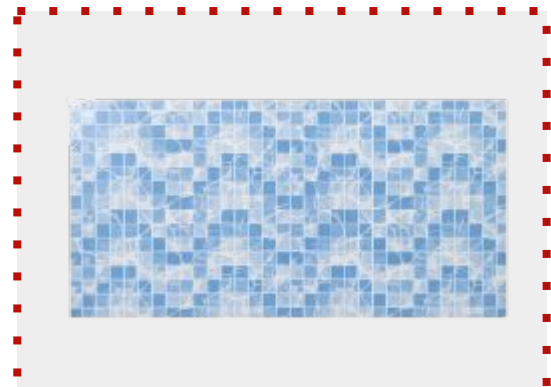

**CARIBE AZUL 30X60 1A MT (1.62)**



**CARTAGENA MARMOL 30X60  
PISO-PARED 1A MT.**



**CARTIERE CREMA 45X90 1A MT. (1.62)**





**CASTELLON HUMO 30X60 1A MT. (1.62)**



**CASTELLON MULTICOLOR 20x20 UND**



**CASTELLON TERRA 30X60 1A MT. (1.62)**



**CASTILLA BEIGE 60X60 1A MT. (1.80)**



**CASTILLA GRIS 60X60 1A MT. (1.80)**

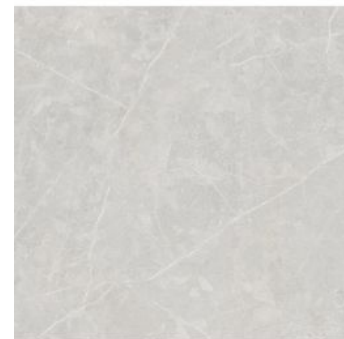

**CATANIA 60X60 1A MT. (1.80)**



**CENEFA 15X45 CHESS AROMA  
INTERMATEX**

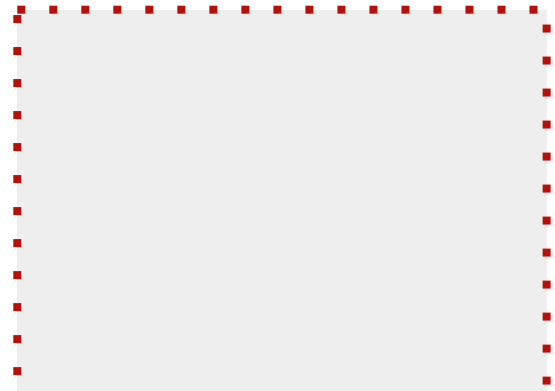

**CENEFA 15X45 CIRCULOS ROJO  
NEGRO SICHAR**



**CENEFA 15X45 DAMA MARMOL  
INTERMATEX**



**CENEFA 15X45 DAMA MULTI  
INTERMATEX**



**CENEFA 15X45 OVALOS  
GRIS INTERMATEX**



**CENEFA 20X60 VORAMAR BEIGE  
INTERMATEX**



**CENEFA 20X60 VORAMAR MULTI  
INTERMATEX**

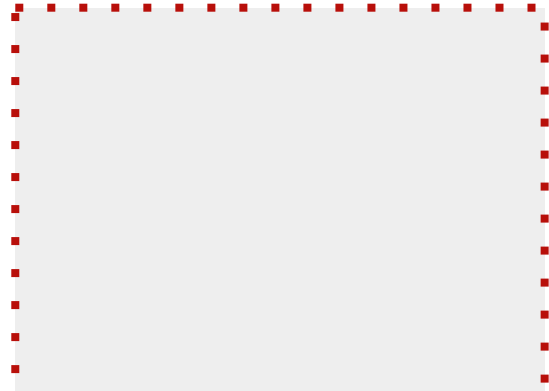

**CENEFA LUNAS AZUL 15X40**



**CIRCON 45X90 1A MT (1.62)**



**COMBO ALUVIA ALONGADO  
CON PED BLANCO**



**COMBO ANDINO BLANCO CON  
PEDESTAL**

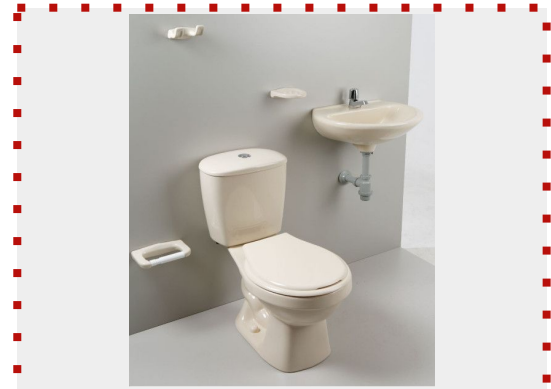

**COMBO HAPPY ROJO BIC CON  
GRIF. 225**

**COMBO LAGUNA AZUL CIELO 111**

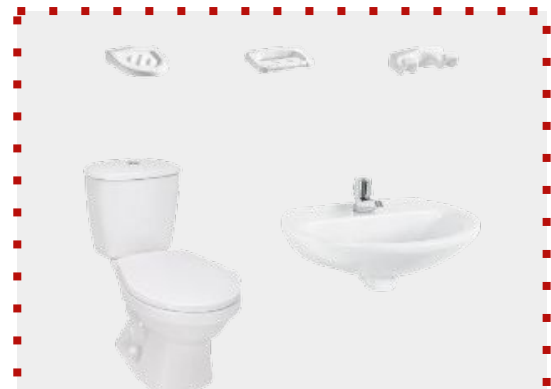
**COMBO LAGUNA BEIGE 103**

**COMBO LAGUNA BEIGE CON PED 103**

**COMBO LAGUNA BLANCO 100**

**COMBO LAGUNA BLANCO CON PED 100**

**COMBO MANANTIAL BEIGE CON  
PED 103**

**COMBO MANANTIAL BEIGE SIN  
PED 103**

**COMBO MANANTIAL BLANCO CON  
PED 100**

**COMBO MANANTIAL BLANCO  
SIN PEDESTAL 100**

**COMBO MANANTIAL PRO MUEBLE  
ELEMANTAL**

**COMBO MONTECARLO REDONDO  
BLANCO 100**

**COMBO MONTECARLO/SOLER  
ALONG BLANCO 100**

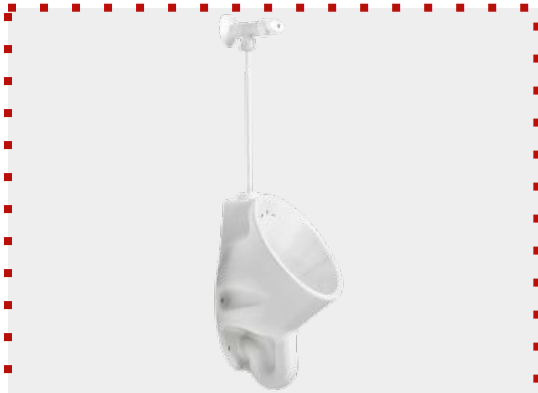

**COMBO ORINAL BARCELONA  
MEDIA BLANCO ROMA**



**COMBO SANIT ONE PIECE LUXOR - LV  
SABINA**



**COMBO SMART ALONG BEIGE 103**



**COMBO SMART ALONG BLANCO 100**

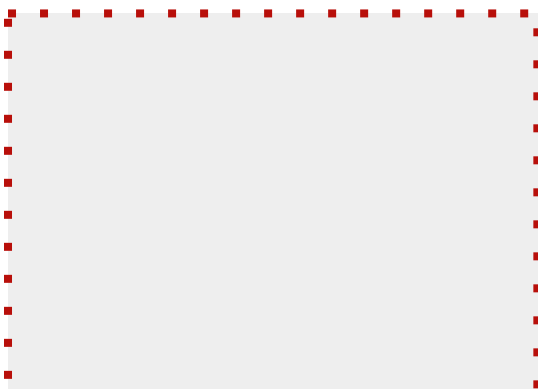

**CONJUNTO FORJA + ESPEJO 60X60  
CM ANT**



**CROCELLA PLATA 45X90 1A MT.(1.62)**



**CUARZO 45X90 1A MT.(1.62)**



**DAVOLI CENIZO 25X75 1A MT. (1.5)**



**DECORADO ALCUDIA AZUL 30X90 UNID**

**DECORADO (1867 25X50) (1872 30X60)  
(3806 30X60) (3826 20X60) (4852 20X60).**



**DECORADO ALCUDIA BEIGE 30X90  
UNID**



**DECORADO ART ARANDA  
BLANCO/NEGRO 30X60**

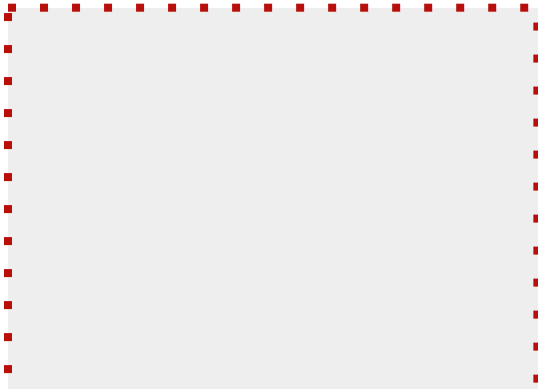

**DECORADO BOWEN RECTA 20X60**

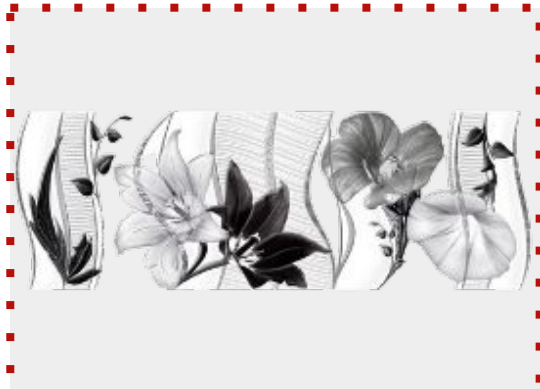

**DECORADO DALIA GRIS 30X90 UNID**



**DECORADO FRUTAL RECTA 20X60**



**DECORADO GERBERA ROJO 9X40**



**DECORADO GLASS AZUL 25X75 UNID**

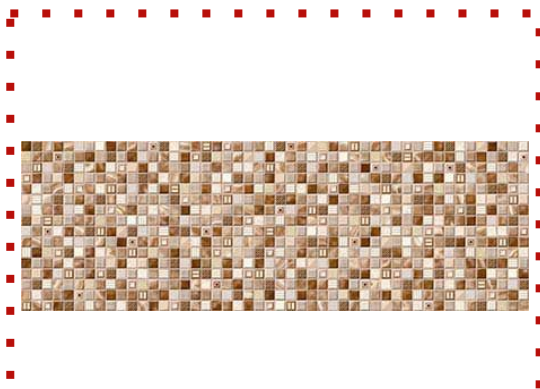

**DECORADO GLASS MARRON  
25X75 UNID**





**DECORADO HOJARASCA MARRON  
25X50 HOLI**

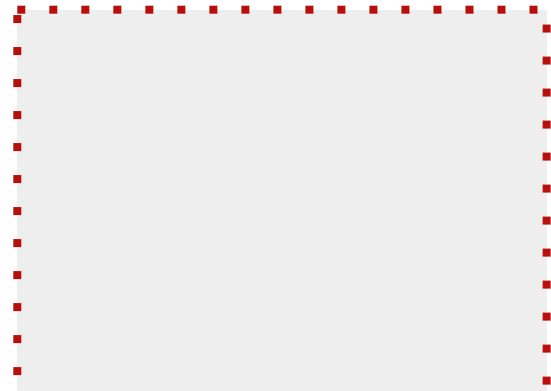

**DECORADO MARIA ELIZA VERDE 15X40**



**DECORADO MENU RECTA 20X60**

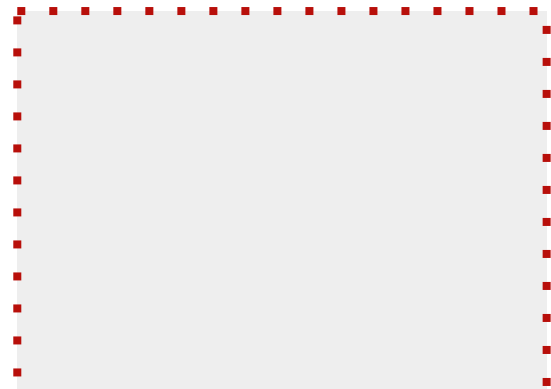

**DECORADO MODELO (1870 30X60 UNID)  
(3183 15X40 UNID) (5305 15X40 UNID).**

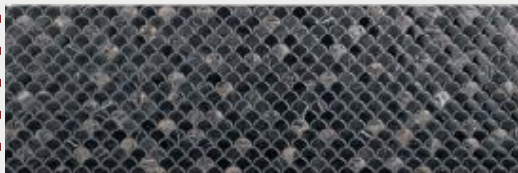

**DECORADO MOS LUCIA NEGRO  
30X90 UNID**



**DECORADO OIL DB 20X60 AZURRA**

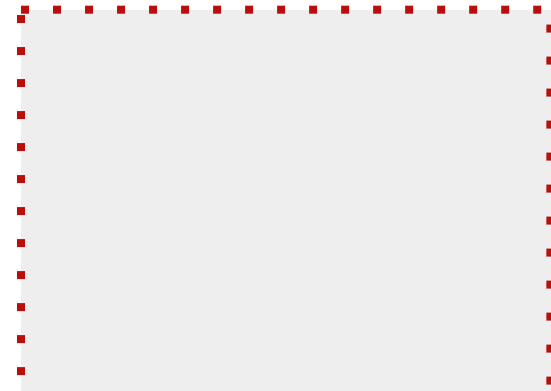

**DECORADO PARTY AZUL 27X45 HOLI**

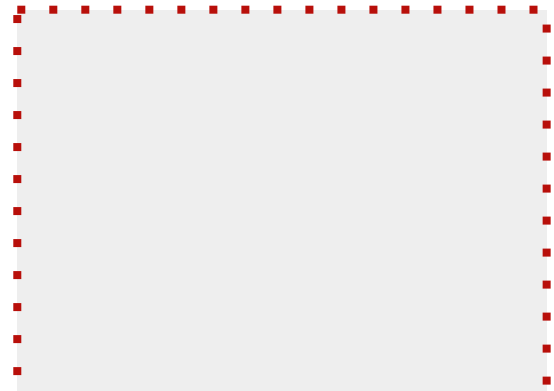

**DECORADO TESUTO PEARL ROJO  
20X60 AZURRA**



**DECORADO TESUTO VAZY TURQUESA  
20X60 AZUR**

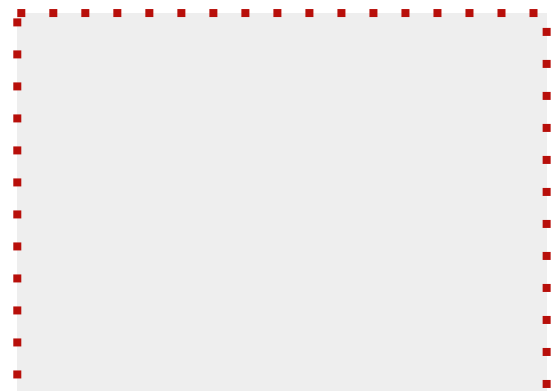

**DECORADO VIENA KITCHEN 20X60 UNID**

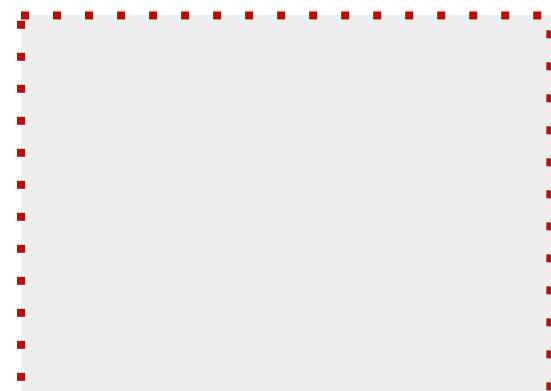

**DELHI MULTICOLOR 20x20 UND**



**DIAMANTE BATTISTI 60X60 1A MT.(1.8)**



**DIAMANTE CIPOLLINI 58X1,18 1A MT (2.07)**



**DIAMANTE DINAMO 60X60 1A MT. (1.80)**



**DIAMANTE DOMITY 60X60 1A. MT. (1.8)**



**DIAMANTE DUCAL 58X1.20 1A MT. (2.07)**



**DIAMANTE HORTENSIA 60X60 1A. MT.(1,8)**

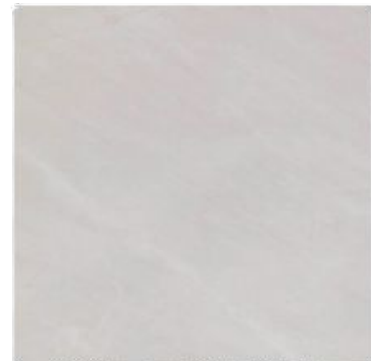

**DIAMANTE MILAZZO 60X60 1A MT.(1.8)**

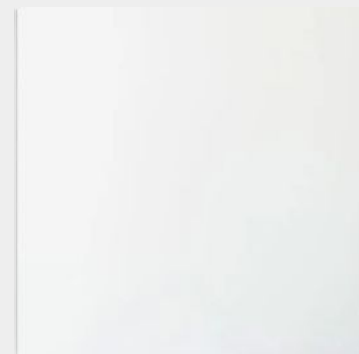

**DIAMANTE NUVOLATO 58X1,18 1A MT. (2.07)**

**DIAMANTE ONIX GOLD CYR 60X60  
1A MT (1.8)**

**DIAMANTE PERLADO BEIGE 60X60  
1A MT (1.8)**

**DIAMANTE ROYAL BLANCO RECTI  
60X60 (1.8)**

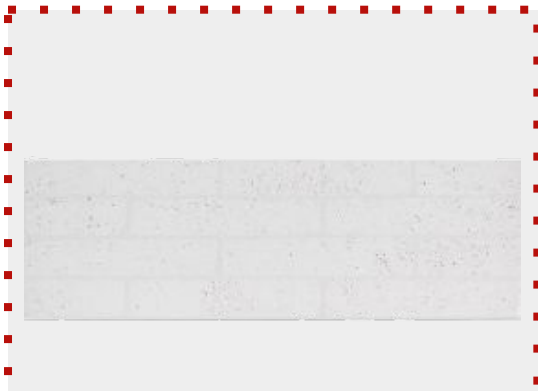
**DIAMANTE UFIZI PERLA 58X118  
1A MT (2.07)**

**DIAMANTE VEZZIO BEIGE 60X60  
1A MT.(1.8)**



**DOLCETTO BLANCO 25X75 1A MT. (1.50)**



**DUCAL MATE 58X118 1A MT.(2.07)**

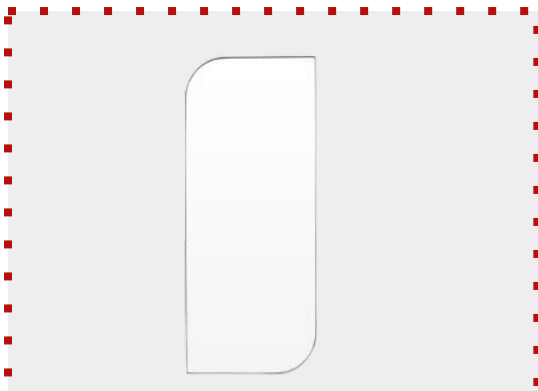

**ESPEJO ESTUDIO EBANO**

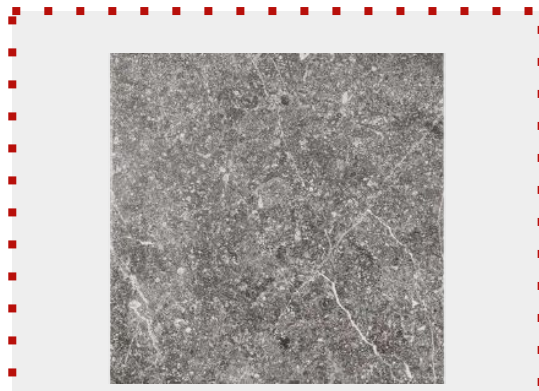

**EXTERIOR ARAGON 60X60 1A MT. (1.8)**

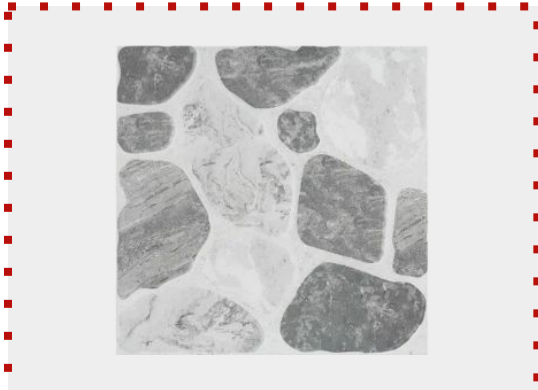

**EXTERIOR MEDELLIN BEIGE 60X60  
MT. (1.80)**



**EXTERIOR NARDO 45436 45X45  
1A MT. (2.25)**



**EXTERIOR PIED CUZCO 45446**  
45X45 MT.(2.25)



**FACHADA ANDES BLANCO 34X50**  
1A MT. (1.19)



**FACHADA ANDES NEGRO 34X50**  
MT. SICHA (1)



**FACHADA BERA BEIGE 25X50**  
1A MT. (1.5)



**FACHADA BERA CALIZA MATE**  
25X50 MT. (1.5)

**FACHADA CALEDONIA 60063HD**  
32X57 MT.(2.04)

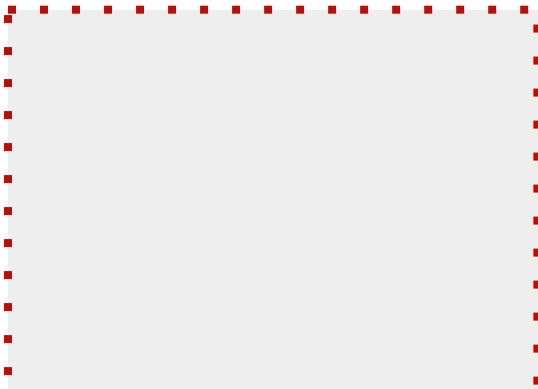

**FACHADA CELESTON BIANC 30X60  
1A MT(0.90)**

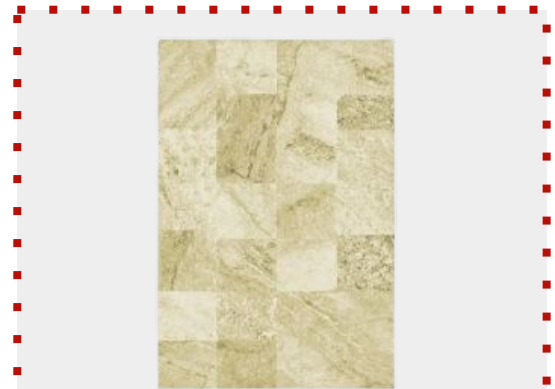

**FACHADA DAKOTA BEIGE 30X45  
1A MT. (1.51)**

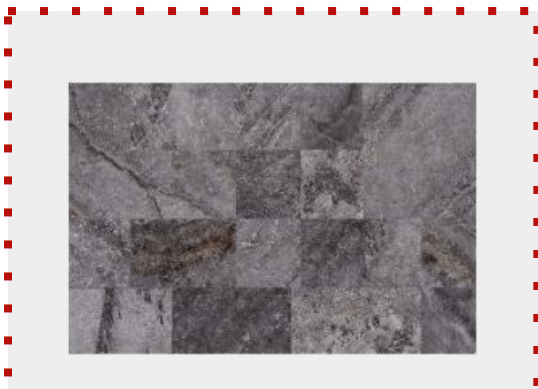

**FACHADA DAKOTA GRIS 30X45  
1A MT (1.51)**



**FACHADA INFINITY MOZZART 30X60  
MT (0.90)**

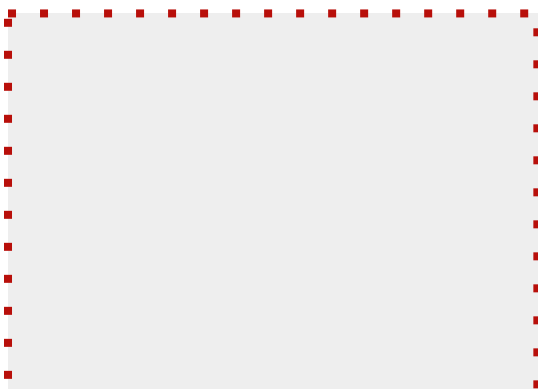

**FACHADA MARMOTH BEIGE 30X60  
1A MT.(0.90)**



**FACHADA NIAGARA BEIGE 34X60  
1A MT.(2.10)**

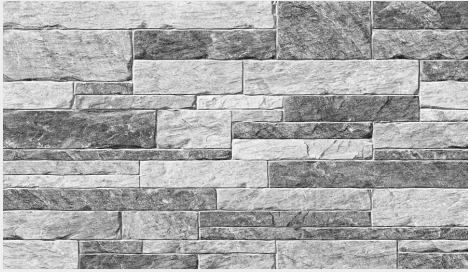

**FACHADA NIAGARA CENIZA 34X60  
1A MT. (2.1)**



**FACHADA OASIS OPALA 1A MT.  
SICHAR (1.51)**



**FACHADA OASIS PEROLA 31X54  
1A MT. (1.51)**



**FACHADA OASIS SEVILHA 34X50  
1A MT (1.51)**

**FACHADA ORDINO GRIS 34X50  
1A MT. (1.19)**



**FACHADA PALAZZO BEIGE 32X56  
1A MT (1.51)**



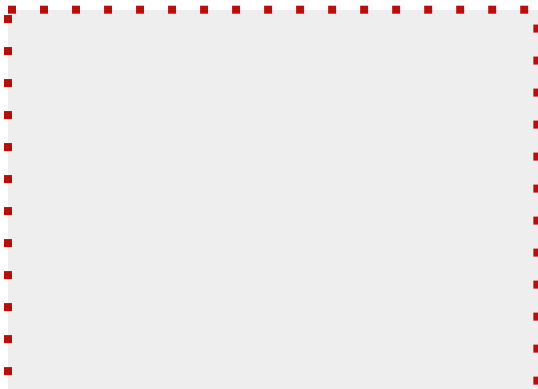

**FACHADA PANDORA OLD 34X60  
1A MT. (2.10)**

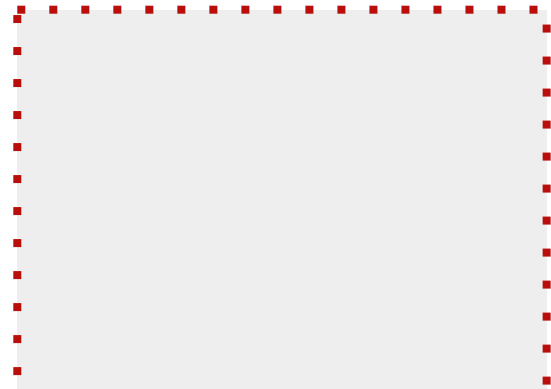

**FACHADA PIANO STONE 30X60  
1A MT.(0.90)**



**FACHADA PRISMA CARRARA  
1A MT SICHA(1.34)**

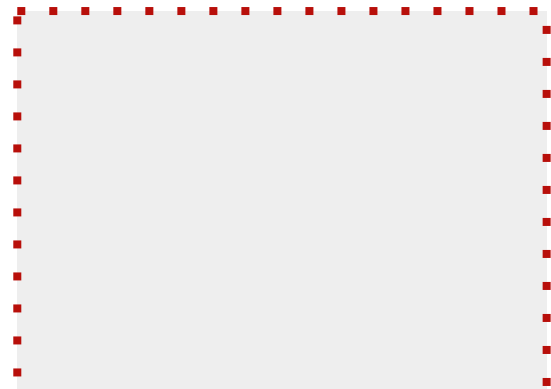

**FACHADA PRISMA LUX BLANCA  
32X57 MT(1.34)**



**FACHADA PRISMA PIETRA 32X57  
1A MT (1.34)**



**FACHADA TOSCANA BRICK  
34X60 1A MT.(2.10)**

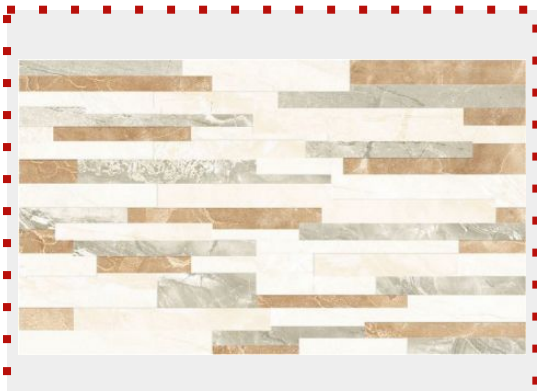

**FACHADA VILLA BGE HD57313**  
33X57 1A (2.5)

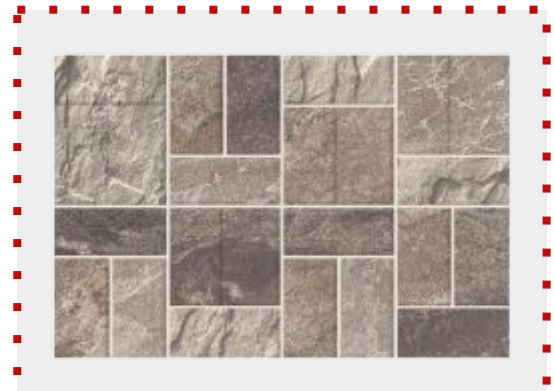

**FACHAL ESTR LILIBETH CAFE**  
CD 30X45(1.89)

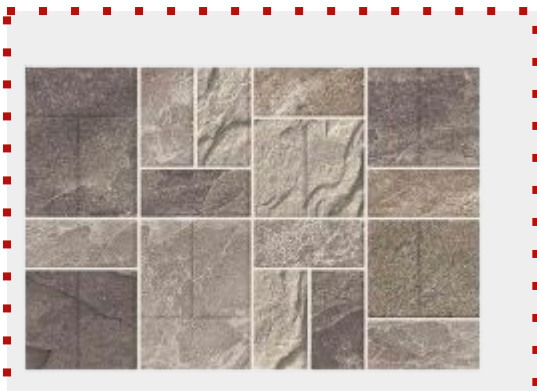

**FACHAL ESTR LILIBETH GRIS**  
CD 30X45(1.89)

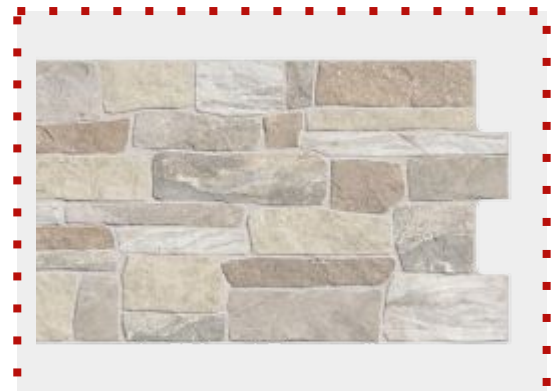

**FACHALETA CORRIENTES MARFIL**  
34X62 (1.71)



**FACHALETA MURETO MISSOURI**  
MT (1.45) ALFA

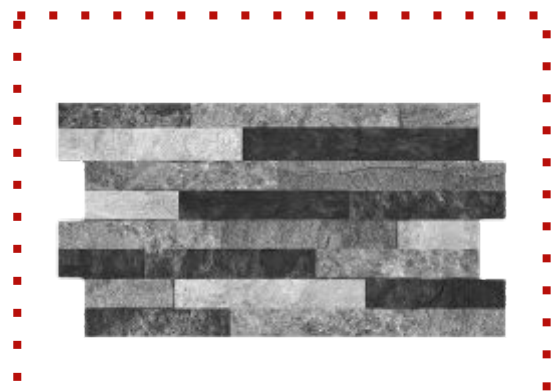

**FACHALETA TUNJO NEGRO 34x62 1A**  
MT (1.71)



**FACHALETA USUL BEIGE CD**  
34X62 MT. (1.71)



**FACHALETA USUL GRIS CD 34X62**  
1A MT(1.71)

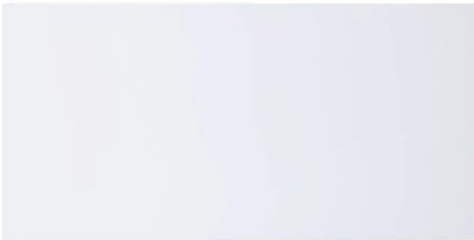

**FONTANA BIANCO 30X60 1A MT. (1.62)**



**FORTEZZA ALMENDRA 30X60**  
1A MT. (1.62)



**GALIKO 25x75 1A MT (1.50)**

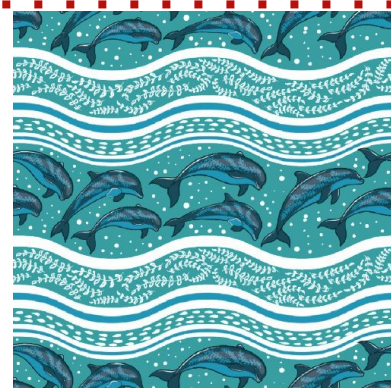

**GOLFIN MULTICOLOR 20x20 UND**



**INCINO GREY 45X90 1A MT. (1.62)**



**JASPE 58X118 1A MT. (2.07)**



**JUGO VERDE MULTICOLOR 20x20 UND**



**KIT LAVAMANOS BARI BLANCO  
MUEB. TIZIANO**



**KIT LAVAMANOS BIOSEGURIDAD  
EN PORCEL+**



**KIT LAVAMANOS RIO BLANCO  
MUEB. VALDEZ**



**KIT LAVAMANOS SIENA MARFIL  
MUEB. BASICO**



**LAPIZ CARAMELO SICHAR**



**LAPIZ VERDE SICHAR**



**LASILA 19X1.18 RECTIFICADO 1A MT (1.14)**



**LAVAMANOS AVANTI BEIGE**



**LAVAMANOS AVANTI BLANCO CON PED**

**LAVAMANOS CALIZ NEGRO TU CASA**

**LAVAMANOS CASCADE ARENA MATE**

**LAVAMANOS CASCADE GRIS MATE**

**LAVAMANOS CASCADE NEGRO BRILLANTE**

**LAVAMANOS CASCADE NEGRO MATE**

**LAVAMANOS CASCADE VESSEL BLANCO**

**LAVAMANOS COBRE 35 CM ANT**

**LAVAMANOS CUADRADO TURIN  
BLANCO 38X38**

**LAVAMANOS DALAI GRIS VESSEL TC**

**LAVAMANOS DALAI NEGRO VESSEL TC**

**LAVAMANOS EDEN BLANCO 41X41 TC**

**LAVAMANOS ELIPSE 60 CON  
DESAGUE BEIGE**



**LAVAMANOS ELIPSE 60 CON  
DESAGUE BLANCO**



**LAVAMANOS GLOSSY CARRARA**



**LAVAMANOS HAPPY BLANCO 100**



**LAVAMANOS IBIZA BLANCO ROMA**



**LAVAMANOS INCRUSTAR MERIDA BLANCO**



**LAVAMANOS INTER BLANCO 81X46 TC**



**LAVAMANOS KORAL DARK VESSEL TC**

**LAVAMANOS LIQUID VESSEL BLANCO**

**LAVAMANOS MANANTIAL DUO BEIGE**

**LAVAMANOS MARBEL BLANCO 51X44  
TU CASA**

**LAVAMANOS MARSELLA BLANCO  
EMP. SIN GRIF**

**LAVAMANOS MILANO BEIGE SIN PED 103**

**LAVAMANOS MILANO BLANCO 100**

**LAVAMANOS MILANO BLANCO  
SIN GRIF CON PED**

**LAVAMANOS OSLO BLANCO VESSEL TC**

**LAVAMANOS OSLO CARRARA VESSEL TC**

**LAVAMANOS PARIS BLANCO  
53X46 4003 TC**

**LAVAMANOS PARIS IVORY 53X46 TC**



**LAVAMANOS PONTUS 60 CON  
DESAGUE BLANCO**



**LAVAMANOS PORTO BLANCO TU CASA**



**LAVAMANOS PORTUGAL IVORY VESSEL TC**



**LAVAMANOS PRISMA DORADO ITALIA**



**LAVAMANOS ROMA BLANCO 61X46 TC**



**LAVAMANOS TIPO VESSEL IVORY  
PRAGA DM**



LAVAMANOS VELENTY BLANCO  
40X33 5021 TC



LAVAMANOS VELENTY IVORY  
40X33 5021 TC



LAVAMANOS VENTO CARRARA VESSEL TC



LAVAMANOS VESSEL ACACIA BEIGE EURO



LAVAMANOS VESSEL ACACIA  
BLANCO EURO



LAVAMANOS VESSEL ALAMO  
BLANCO EURO



**LAVAMANOS VESSEL BLANCO PRAGA  
32X32X13DM**



**LAVAMANOS VESSEL KAMIL  
BLANCO GRIS DG**



**LAVAMANOS VESSEL KARIM BLANCO D.G**



**LAVAMANOS VESSEL KENAN BLANCO DG**



**LAVAMANOS VESSEL KILIAN BLANCIO DG**



**LAVAMANOS VESSEL KLAU BLANO D.G**

**LAVAMANOS VESSEL KRISTEL BLANCO**

**LAVAMANOS VESSEL KYRA BLANCO**

**LAVAMANOS VESSEL NEGRO  
BILBAO 40X40X14DM**

**LAVAMANOS VESSEL NEGRO  
MUNISH 46X35X13.5**

**LAVAMANOS VESSEL OVA  
L BEIGE 50CM EURO**

**LAVAMANOS VESSEL OVAL  
BLANCO 50CM EURO**



**LAVAMANOS VESSEL SABINA  
BEIGE EURO**



**LAVAMANOS VITAL BONE 41X41  
VESSEL TC**



**LIMOS GREY 45X90 1A MT. (1.62)**

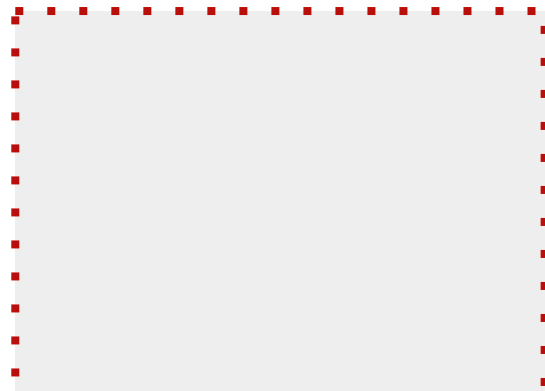

**LISTELLO 360 8X30**



**LISTELLO ALICANTE VERDE 6.5X25**



**LISTELLO ALLEGRO CAFE**



**LISTELLO ALLEGRO VERDE**

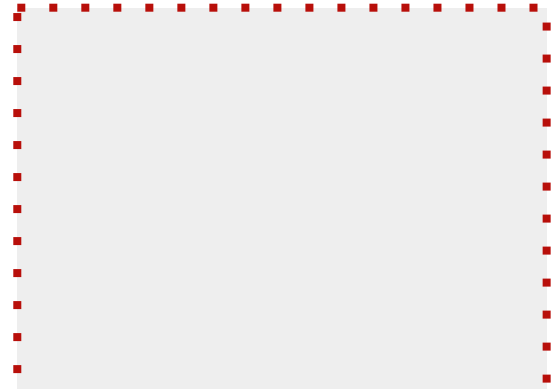

**LISTELLO AMORE 8X25**



**LISTELLO ARABEZCO AZUL 6X20**



**LISTELLO ARABEZCO CAFE 6X20**



**LISTELLO ASSAM MULTICOLOR 8X25**



**LISTELLO ASTRAL AZUL 8X25**





**LISTELLO ASTRAL NEGRO 8X25**



**LISTELLO ASTRAL ROJO 8X25**



**LISTELLO ASTRAL VERDE 8X25**



**LISTELLO ATILA TERRACOTA 8X25**

**LISTELLO AZUL FLO26**



**LISTELLO BABEL AZUL 8X25**



**LISTELLO BABEL CAFE 8X25**



**LISTELLO BOLONIA CAFE 8X25**



**LISTELLO BOREAL AZUL 6X20**

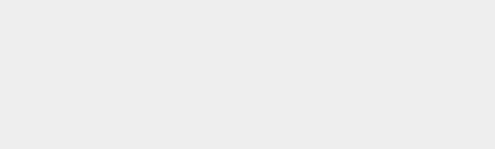

**LISTELLO BOREAL VERDE 6X20**



**LISTELLO BOULEVARD VERDE**

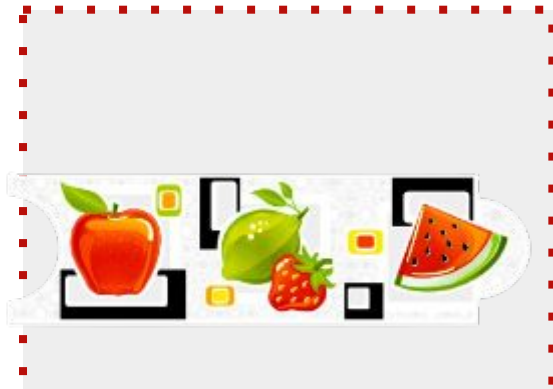

**LISTELLO BRECCIA AZUL 6X20**

**LISTELLO CALENDAS MULTICOLOR 8X25**

**LISTELLO CEREZOS ROJO 8X25**

**LISTELLO CHEFCITO 2 VERDE 8X25**

**LISTELLO CHERRY UNICO 6.5X25**

**LISTELLO COLOMBO CAFE 8X25**

**LISTELLO COLOMBO MULTICOLOR 8X25**

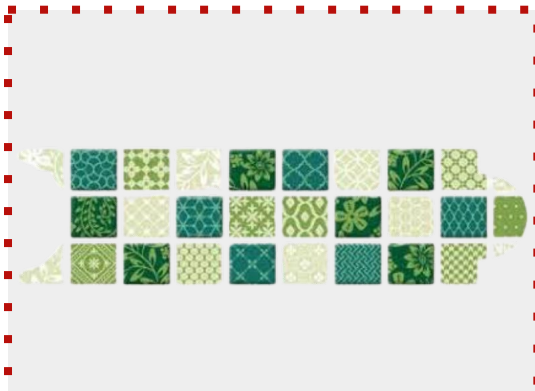

**LISTELLO COLOMBO VERDE 8X25**



**LISTELLO COLONNA MULTICOLOR 8X25**

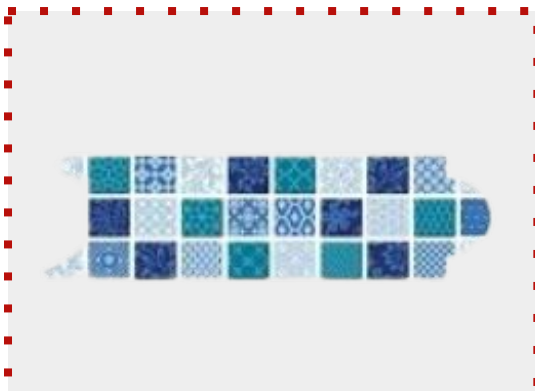

**LISTELLO COLORY AZUL 8X25**

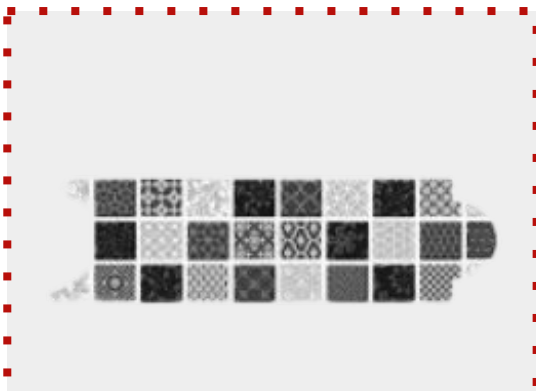

**LISTELLO COLORY NEGRO 8X25**



**LISTELLO COLORY ROJO 8X25**

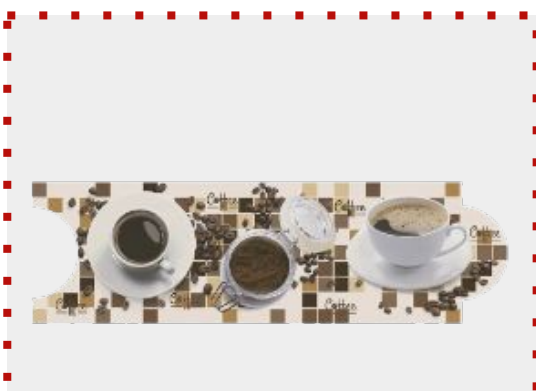

**LISTELLO DEVA COFFE CAFE 10X25**

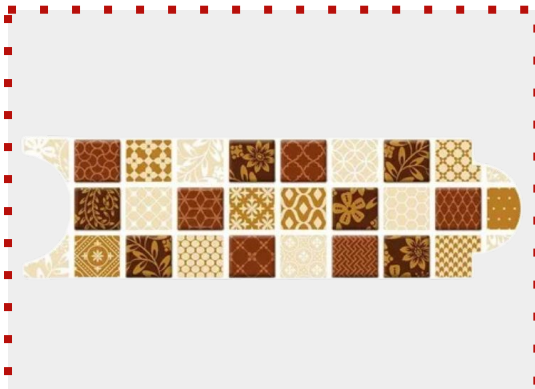

**LISTELLO DF-1118A ARAB MARRON  
8X25**



**LISTELLO DF-1627D NATALY AZUL 8X25**

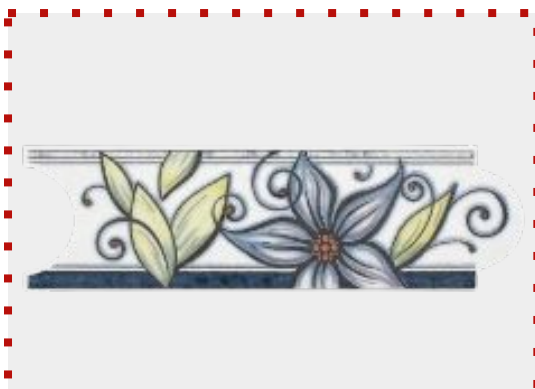

**LISTELLO DF-266D MARGARITA AZUL  
8X25**



**LISTELLO DFJ-2065 ELITE COCINA  
8X25**

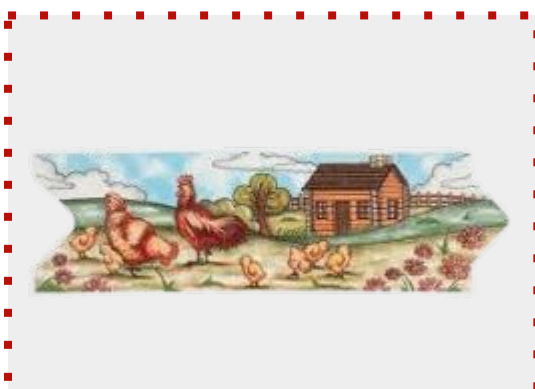

**LISTELLO DFJ-232A ZAFIRO  
BEIGE 8X25**



**LISTELLO DINAMARCA AZUL 8X25**



**LISTELLO DINAMARCA NARANJA  
8X25 SALDO**

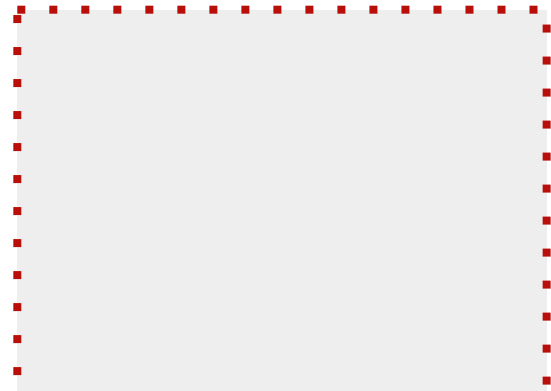

**LISTELLO DINAMARCA ROJO  
8X25 (SALDO)**

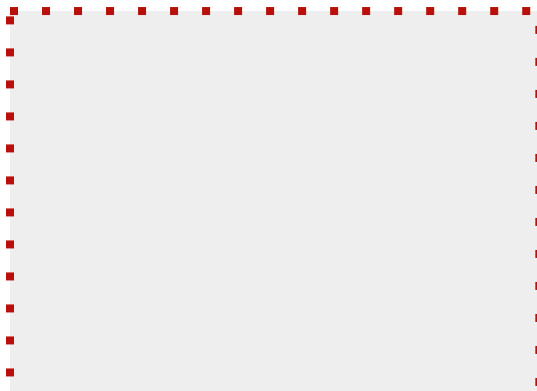

**LISTELLO DINAMARCA VERDE 8X25**



**LISTELLO DK 118A**



**LISTELLO DK-518E JARRAS CAFE 8X25**



**LISTELLO DKJ-208 ROMBOS  
VERDE 8X25**



**LISTELLO ESFERA MULTICOLOR**



**LISTELLO FIDJI BEIGE 8X25**



**LISTELLO FLOR AZUL 8X25**



**LISTELLO FLOR NEGRO 8X25**



**LISTELLO FLOR ROJO 8X25**



**LISTELLO FRUTERA AZUL DFJ-2063D  
8X25**



**LISTELLO FRUTERA MARRON  
DFJ-2063A 8X25**



**LISTELLO GALES BLANCO**



**LISTELLO GARDEN TERRACOTA 8X25**



**LISTELLO HORIZONTE VERDE**



**LISTELLO IRAZU FLOR AZUL 10X25**



**LISTELLO ISABELLA DKJ-1278 8X25**



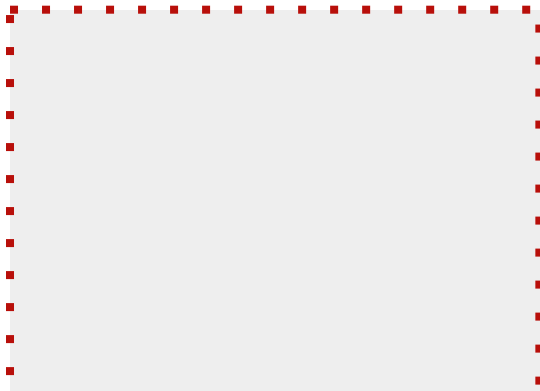

**LISTELLO ISABELLA DKJ-1278 8X25**

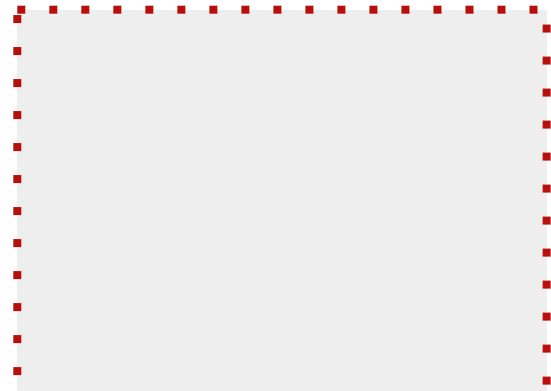

**LISTELLO JARANA MULTICOLOR 10X25**



**LISTELLO JARRAS AZUL 8X25**



**LISTELLO JUAN VALDEZ 8X25**

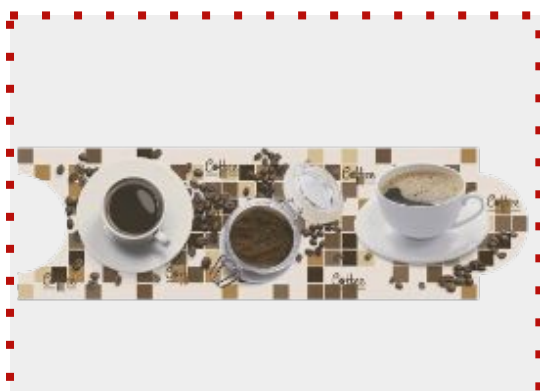

**LISTELLO KITCHEN CAFE 8X25**



**LISTELLO LACASITOS NARANJA 8X25**



**LISTELLO LACASITOS NEGRO 8X25**



**LISTELLO LACASITOS VERDE LIMON 8X25**



**LISTELLO LIMONETTA VERDE**

**LISTELLO LOIRA AZUL**



**LISTELLO LORCA CAFE 8X25**

**LISTELLO LUNA AZUL 8X25**



**LISTELLO LUNA MARRON 8X25**

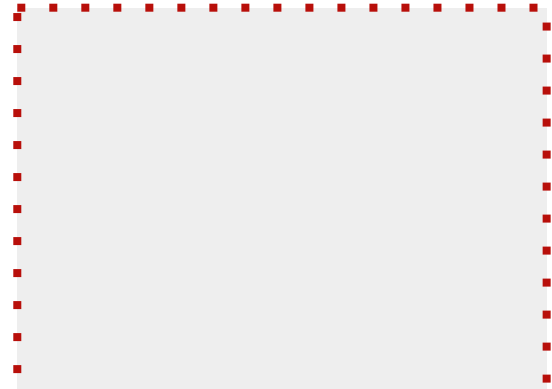

**LISTELLO LUNA VERDE 8X25**



**LISTELLO MANGO 8X25**

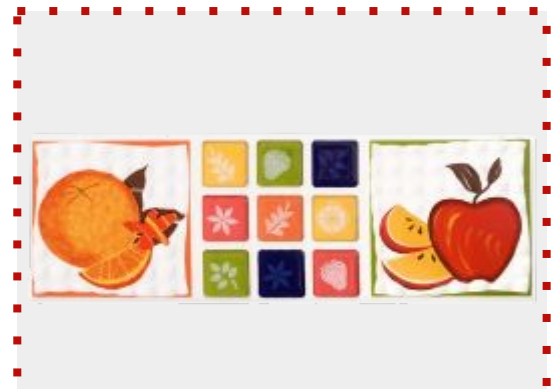

**LISTELLO MANZANA 10X30**



**LISTELLO MARGARITAS VERDE  
(TEAL) 8X25**

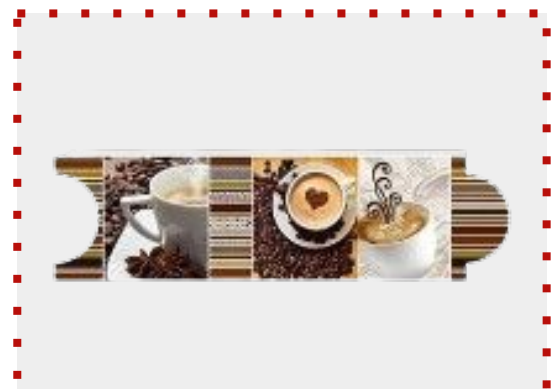

**LISTELLO MECINA CAFE 8X25**

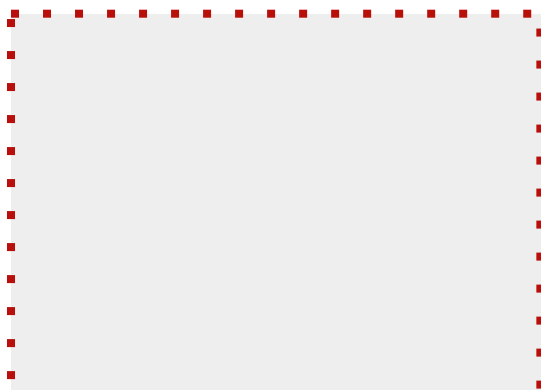

**LISTELLO MEDIA LUNA MARRON 8X25**

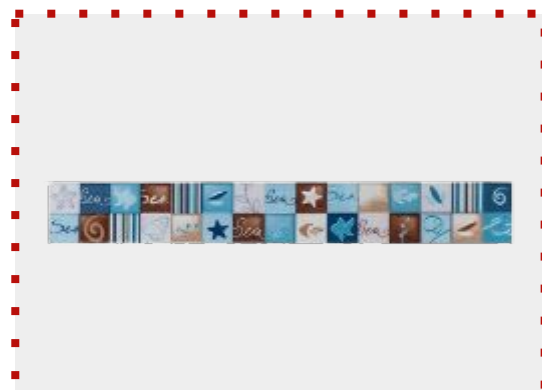

**LISTELLO MEDITERR TIP A MT.**



**LISTELLO MELON 8X25**



**LISTELLO MOANA CAFE 8X25**



**LISTELLO MOANA VERDE 8X25**



**LISTELLO NATURA BEIGE 6.5X25**

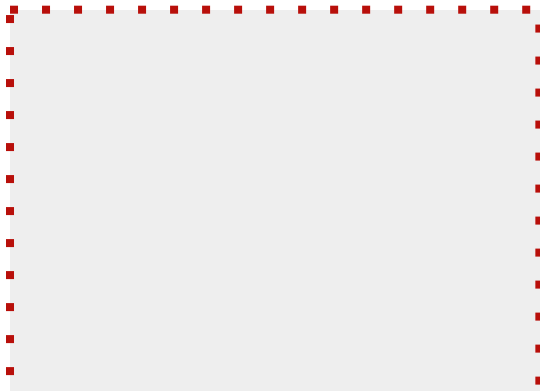

**LISTELLO ONDA NEGRO PLAT. 8 X 25**



**LISTELLO PALERMO NEGRO 8X25**



**LISTELLO PECATTO MULTICOLOR  
8X25**



**LISTELLO PETALOS AZUL 8X25**



**LISTELLO PETALOS NARANJA 8X25**



**LISTELLO PETALOS NEGRO 8X25**



**LISTELLO PETALOS ROJO 8X25**



**LISTELLO R-5007 RECTA 5X20**



**LISTELLO SALPICON 8X25**

**LISTELLO R-5010 RECTA 5X20**

**LISTELLO SF-35 GRIS**

**LISTELLO SF-39 BEIGE 5X20**

**LISTELLO SF-47 GRIS 5X20****LISTELLO SUGAR CAFE 8X25****LISTELLO TAHITI BEIGE 6X20****LISTELLO TAZA CHOCOLATE 8X30****LISTELLO TREBOL AZUL 8X25****LISTELLO TREBOL MARRON 8X25**

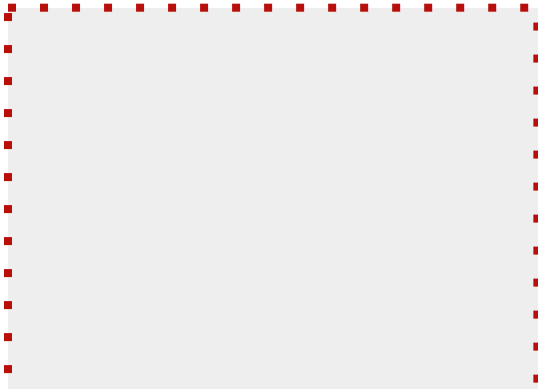

**LISTELLO TREBOL VERDE 8X25**

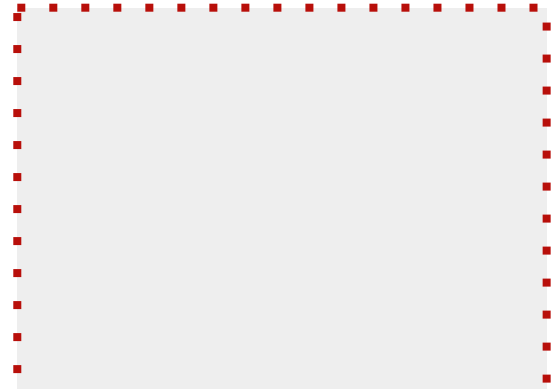

**LISTELLO V-217 VERDE 8X25**



**LISTELLO V-229 BEIGE 8X25**



**LISTELLO V-231 BEIGE 8X25**

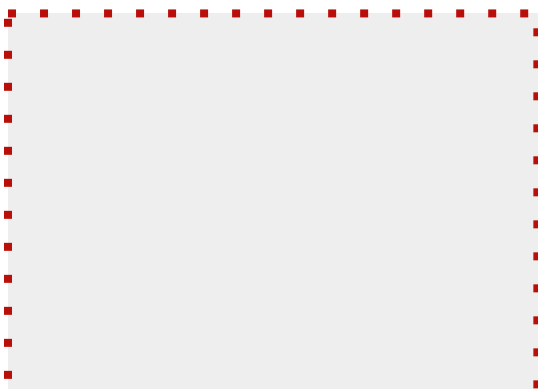

**LISTELLO V-231 GRIS 8X25**



**LISTELLO V-604 ESMERALDA 6X20**



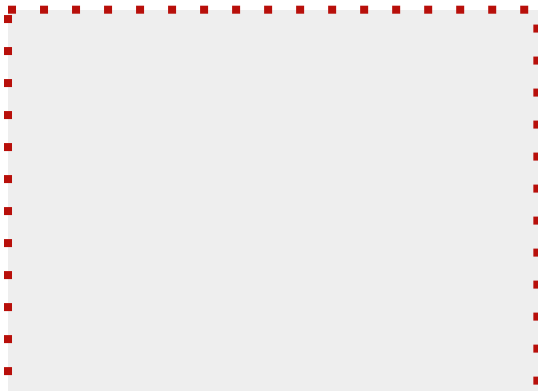

**LISTELLO V-632 BURDEOS 6X20**

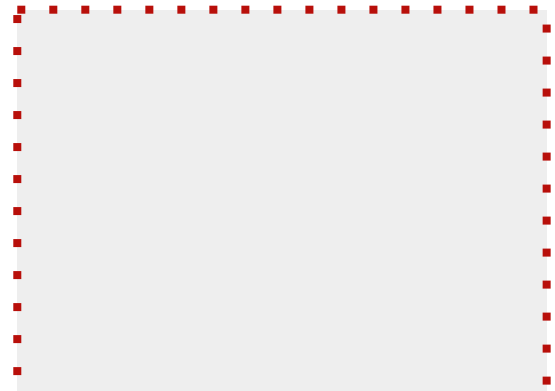

**LISTELLO VAJILLA NEGRA 8X25**

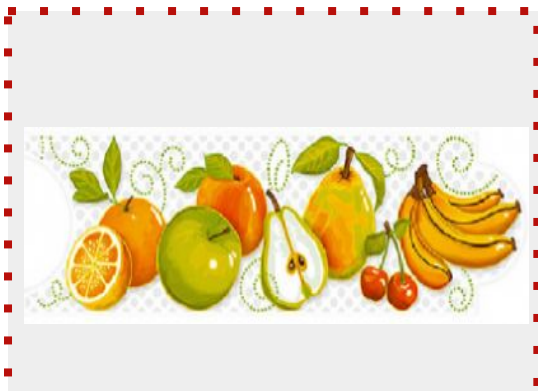

**LISTELLO VERBENA MULTICOLOR 8X25**

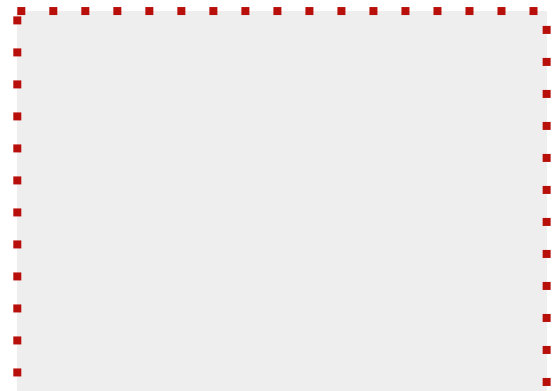

**LISTELLO VILLAREAL MULTICOLOR 8X25**



**LISTON 5280 15X40**

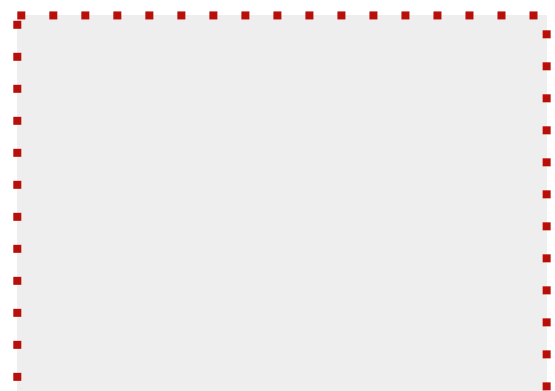

**LISTON ALEGRIA MULTICOLOR 15X40**



**LISTON AMAPOLA ROJA 15X40**



**LISTON AMAPOLA VERDE 15X40**



**LISTON AMERICAN NEGRO 15X40**



**LISTON BANGKOK MULTICOLOR 15X40**



**LISTON BAÑO 2547 15X40**



**LISTON CAMEL MULTICOLOR 15X40**



**LISTON CATANIA OLIVAS  
MULTICOLOR 15X45**

**LISTON COCINA 2296 15X40**

**LISTON COCINA ABUELA  
MULTICOLOR 15X40**



**LISTON CONTRADANZA  
MULTICOLOR 15X40 HOLI**



**LISTON DALIA ROJA 25X40**

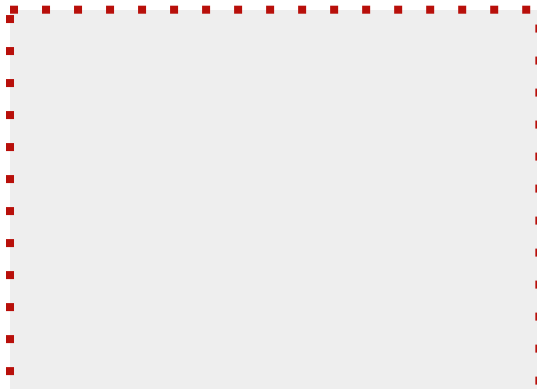
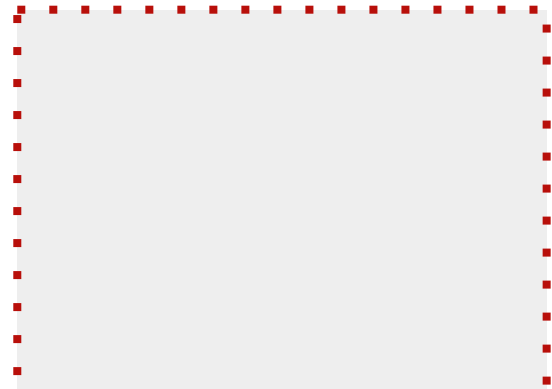

**LISTON ESPARTA NEGRO 15X45**

**LISTON FESTEJO MARRON 15X40**

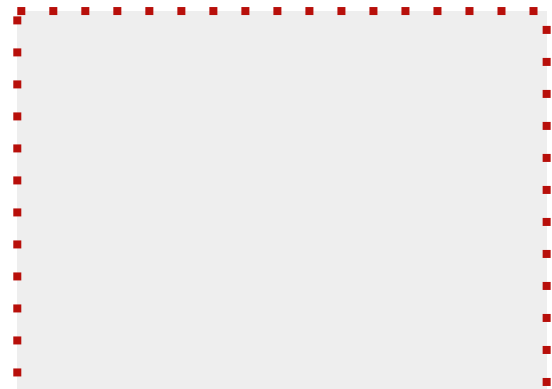
**LISTON FRONDOSO ROJO 15X40**

**LISTON GRECO BEIGE 15X45**

**LISTON ITALIA MARRON 25X40**

**LISTON JANA MULTICOLOR 15X45**

**LISTON JAZZ NEGRO 15X45 HOLI**



**LISTON KORE MULTICOLOR 15X45**  
CAJA X 2 UN



**LISTON LATTE 20X60**



**LISTON MACEDONIA MULTICOLOR**  
20X60



**LISTON MANCHESTER**  
MULTICOLOR 15X40



**LISTON MARGOT NEGRA 15X45**



**LISTON MERENGUE FRESA**  
MULTI 15X40 HOLLI



**LISTON MERENGUE MANZANA  
MULTICOLOR 15X40**



**LISTON MILAN NEGRO 15X40**



**LISTON MILAN ROJO 15X40**



**LISTON MILCA MULTICOLOR 15X45**



**LISTON MONTECARLO MULTICOLOR 15X45**



**LISTON MULATA CAFE 15X45**



**LISTON ORBIT ROJO 15X40**

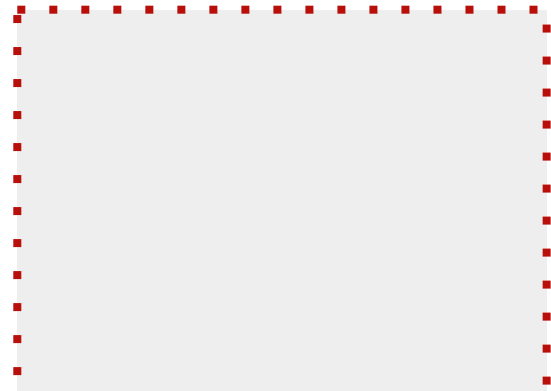

**LISTON PETALOS AZUL 15X40**

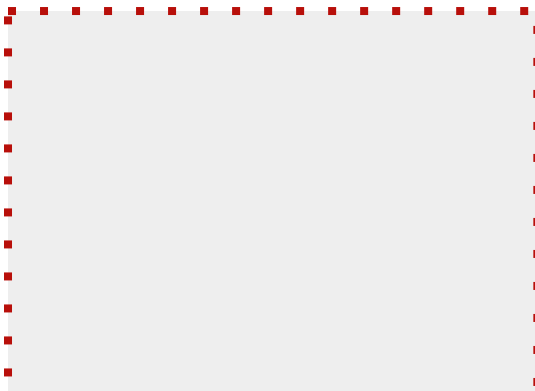

**LISTON PIRAMIDE NEGRA 15X45**

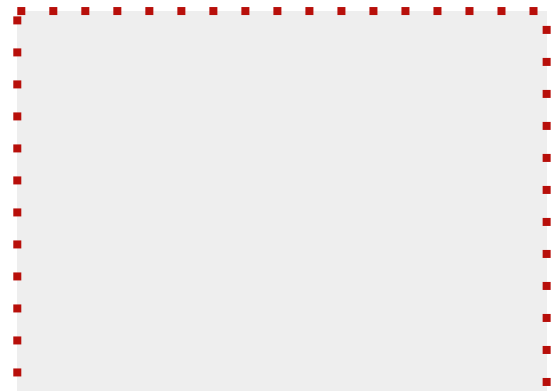

**LISTON PRIMAVERAL MULTICOLOR 15X40**



**LISTON ROYAL NEGRO 13X43**



**LISTON SALSA AZUL 15X40 HOLI**

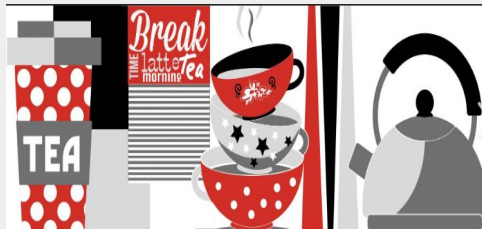

**LISTON SALUT MULTICOLOR 13X43 1A**

**LISTON SELENA MULTICOLOR 15X40**

**LISTON TEA ROJA 15X40**

**LISTON TERMAL AROMA  
MULTICOLOR 15X45**

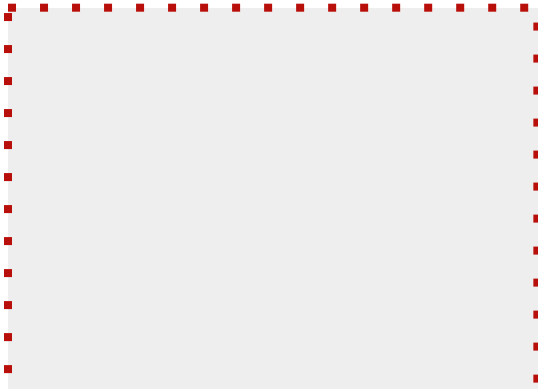
**LISTON TERMAL VELAS MULTICOLOR 15X45**
**LISTON VERONA AZUL 15X40**





**LISTON VERONA ROJA 15X40**



**LISTON ZIMBABWE BEIGE 15X45**



**MACERATA ALMENDRA 45X90 1A  
MT. (1.62)**



**MACERATA AVELLANA 30X60  
1A MT(1.62)**



**MACERATA MARFIL 30X60 1A MT.(1.62)**



**MACERATA WENGUE 30X60 1A MT.(1.62)**

**MADERA ALMENDRO 15X60 1A MT. (1.36)****MADERA ASPEN TAUPE 24X90 1A MT. (1.30)****MADERA CEDRO CENIZO 45X90  
1A MT. (1.62)****MADERA KATIA 25X75 1A MT. (1.50)****MADERA NOGAL CAFE 15X60 1A MT(1.36)****MADERA OZIO 45X90 1A MT. (1.62) SALDO**



**MADERA SABINO 60X60 1A MT. (1.80)**



**MADERA ZEBRANO OSCURA 25X75  
1A MT.(1.5)**



**MADERO CEDRO NATURAL 45X90  
1A MT. (1.62)**

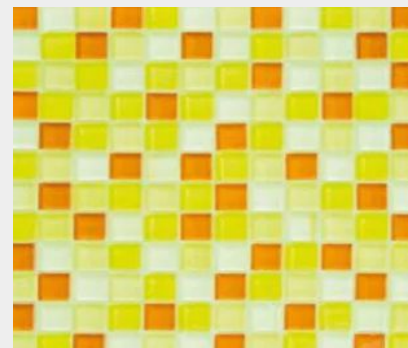

**MALLA CRISTAL 2 30X30 AMARILLA**

**MALLA CRISTAL 2 30X30 BEIGE**

**MALLA CRISTAL 30X30 LUXURY NEGRO**



**MALLA CRISTAL DOVER MIX LATHIG  
30X30**

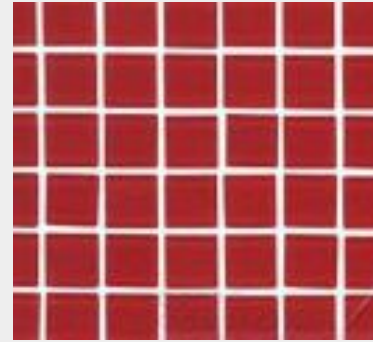

**MALLA CRISTAL ROJO PY01 30X30**



**MALLA CRISTAL SDR15 MADERA 30X30**



**MALLA TERRA BEIGE 30X30 UNID.  
INTERMATEX**

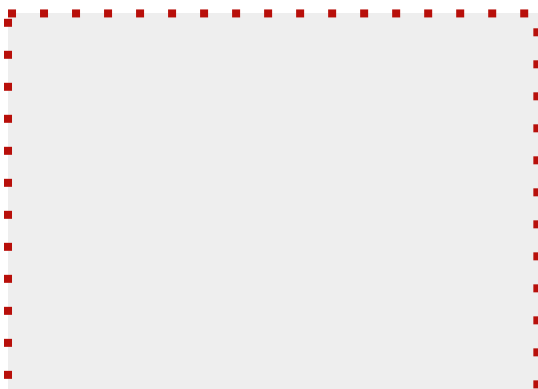

**MANDALA BLANCO PUL. 80X80 1A MT  
. (1.92)**



**MARMOL DOZZA BEIGE 30X60  
1A MT.(1.62)**

**MARMOL VELLETRI 25X75 1A MT. (1.50)**

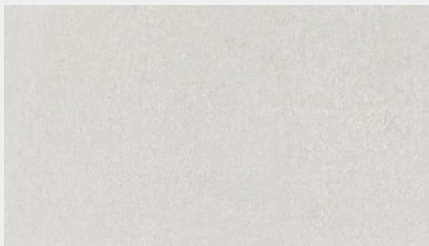
**MILENIO COMPLEMENTO 45X90  
1A MT. (1.62)**

**MONASTIER HUMO 30X60 1A MT. (1.62)**

**MONASTIER HUMO 60X60 1A MT. (1.80)**
**MONOLITH BLACK NATURAL  
60X120 1A. MT.**

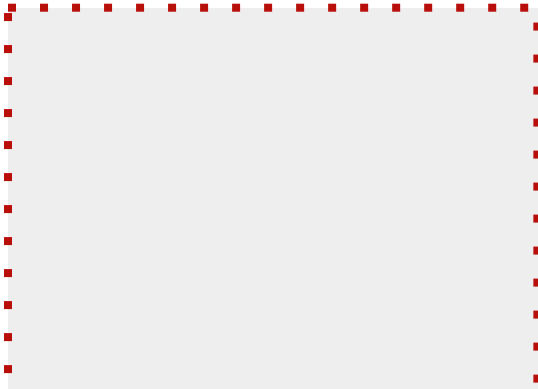
**MORANDI PLOMO 58X1.18 1A MT. (2.07)**

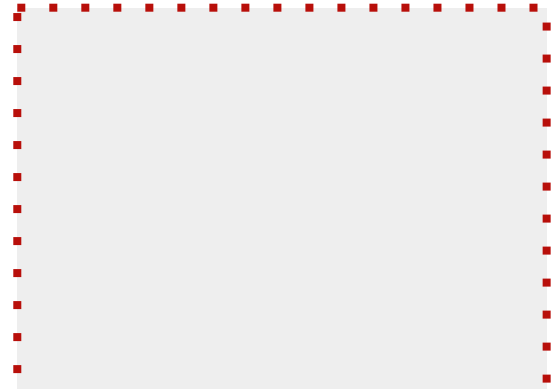

**MOSAICO BIJOU DORADO 29X29 DECORC**



**MOSAICO CARDO MULTICOLOR 30X30 1A**

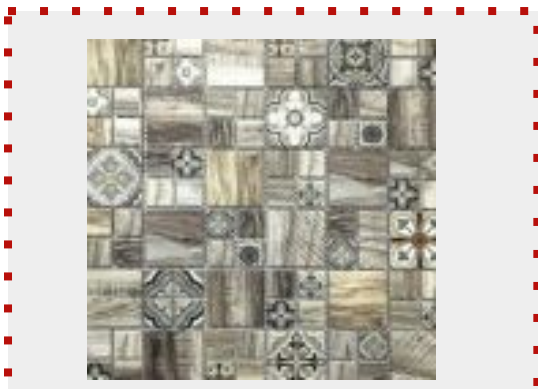

**MOSAICO CINAMMON CAFE 30X30 DECORC**

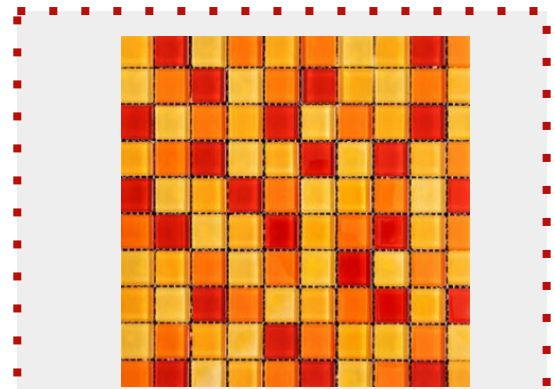

**MOSAICO CONFETI NARANJA 30X30**

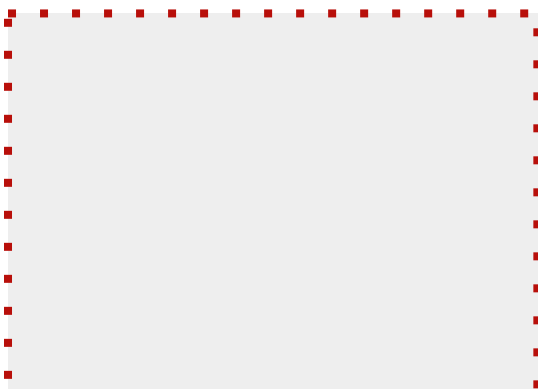

**MOSAICO GEOMETRICO BLANCO 30X30 KN04BL**

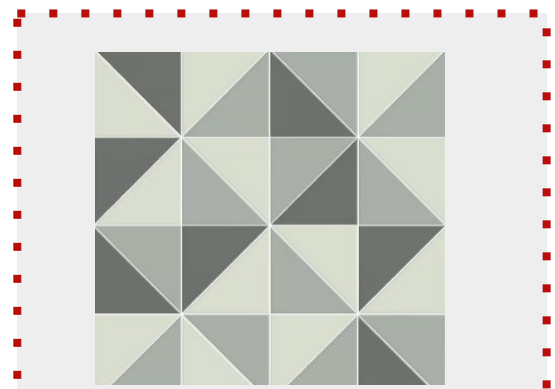

**MOSAICO GLACIAR GRIS 30X30**



**MOSAICO LUXOR NEGRO 30X30 DECORC**

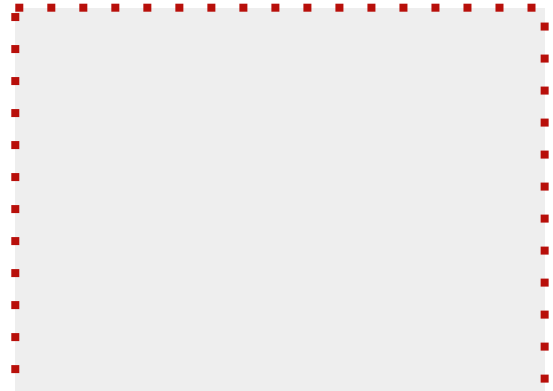

**MOSAICO MARINO AZUL 30X30**



**MOSAICO MARINO ROJO 30X30**



**MOSAICO MARMARA 30X30**



**MOSAICO MENTA MULTICOLOR 30X30**

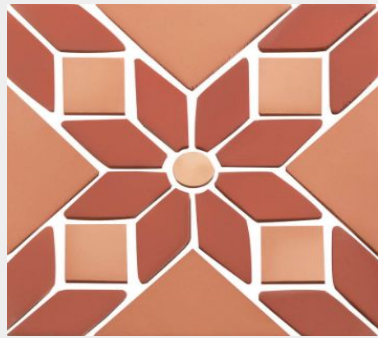
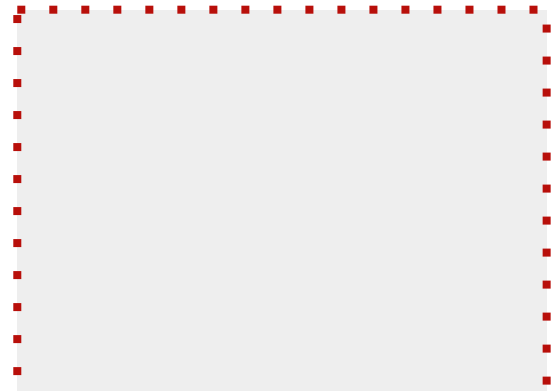

**MOSAICO PAMPLONITA 42 X 11 TEJAR**

**MOSAICO PENELOPE 25X25****MOSAICO SILICE****MOSAICO TE BEIGE 30X30****MOSAICO VALKIRIA NEGRO  
ANTIGUA 30X30****MOSAICO VALKIRIA CAFE  
ANIMALES 30X30****MOSAICO VENECITA AZUL CLARO 32X32**



**MOSAICO YOGURT MULTICOLOR 10X25****MUEBLE FOGGIA 51X46AL PISO  
SIN TAPA ROMA****MUEBLE LAV. TOLEDO WENGUE + GRIF.****MUEBLE LAVAMAN ALUVIA HABANO  
ELEV. 60X45****MUEBLE LAVAMANOS ALUVIA  
CENIZA/CARBON 45****MUEBLE LAVAMANOS ALUVIA  
HABANO 45X45**

**MUEBLE LAVAMANOS ALUVIA MIEL 60X45**

**MUEBLE LAVAMANOS ALUVIA MIEL  
60X45 ELEVA**

**MUEBLE LAVAMANOS ALUVIA  
NOGAL 60X45**

**MUEBLE LAVAMANOS CASCADE  
PLUS 70CM**

**MUEBLE LAVAMANOS CASCADE  
VITAL 60CM INCR**

**MUEBLE LAVAMANOS ELEVADO  
AGAVE 45X45**



**MUEBLE LAVAMANOS ELEVADO  
ARUPO 45X45**

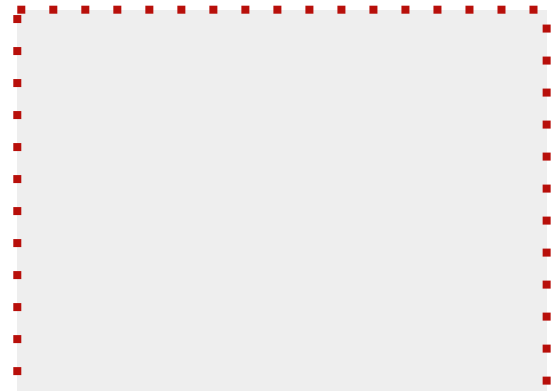

**MUEBLE LAVAMANOS ELIPSE  
PLUS 45CM**



**MUEBLE LAVAMANOS ELIPSE  
PLUS 60CM**



**MUEBLE LAVAMANOS ELIPSE  
PLUS 80CM**



**MUEBLE LAVAMANOS FUSSION  
VITAL 60CM**



**MUEBLE LAVAMANOS GENOVA  
MISUS 63X48**



**MUEBLE LAVAMANOS LISBOA PLUS 60CM**

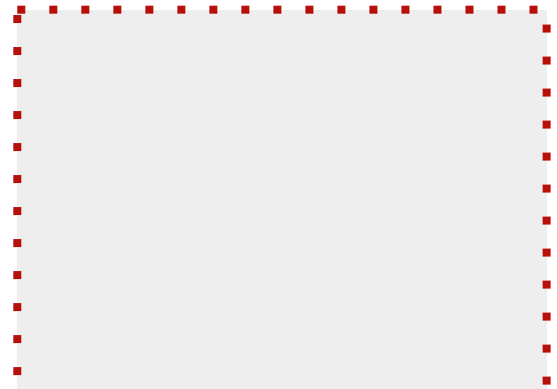

**MUEBLE LAVAMANOS PVC BRALOCH**



**MUEBLE LAVAMANOS PVC Y CERAMICA LONDRES**



**MUEBLE LAVAMANOS SIENA MONET ELEV BLANCO**



**MUEBLE LAVAMANOS SIENA VALDEZ ELEVADO**



**MUEBLE LAVARROPA 80X60 WENGUE FIRPLAK**



**MUEBLE SANITARIO ACTIVE ALONGADO BEIGE**



**MUEBLE SANITARIO ALONGADO ACTIVE BLANCO**



**MUEBLE SANITARIO BASIC BEIGE**



**MUEBLE SANITARIO BASIC BLANCO**



**MUEBLE SANITARIO COMODOR BEIGE**



**MUEBLE SANITARIO COMODOR BLANCO**

**MUEBLE SANITARIO COMODOR COLOR**

**MUEBLE SANITARIO CONFORT  
REDONDO BLANCO**

**MUEBLE SANITARIO REDONDO  
ACTIVE BEIGE**

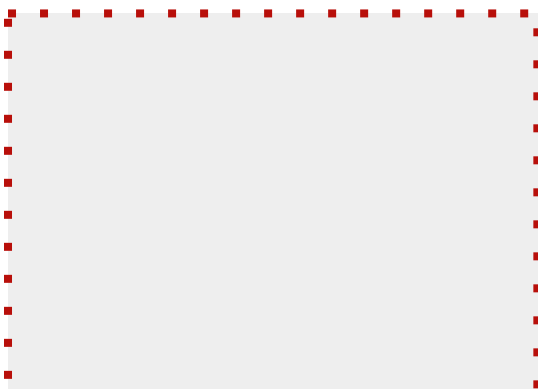
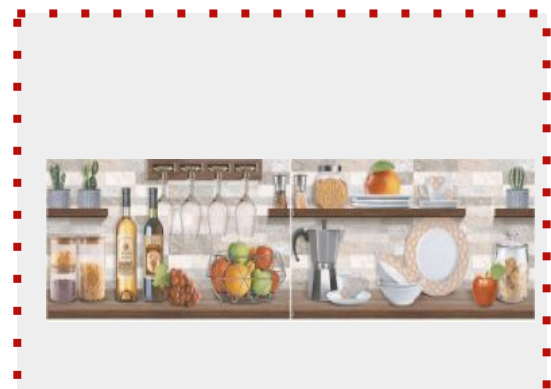
**MUEBLE SANITARIO REDONDO  
ACTIVE BLANCO**

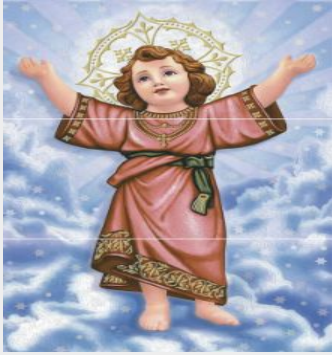
**MURAL ASTRA MULTICOLOR 30X45 1A**

**MURAL COLONNA MULTICOLOR 30X60 2pz**

**MURAL DIVINO NIÑO X 3 PIEZAS 30X60**

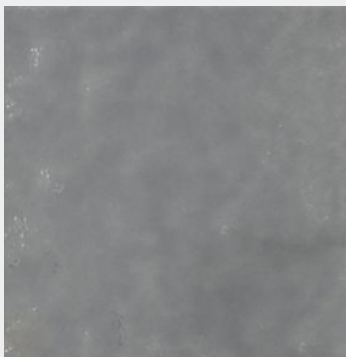
**MURAL SAGRADO CORAZON 30X60  
X 3 PIEZAS**

**MURAL VIRGEN 30X60 X 3 PIEZAS**

**OASIS AZUL MARINO 20X20 1A MT2 (2)**

**OASIS GRIS 20X20 1A MT2 (2)**

**ORINAL MEDIANO LYONS  
BLANCO+GRIF PUSH SE**

**ORNATUM MULTICOLOR 20x20 UND****PALANCIA 58X1.18 1A MT. (2.07)****PALMI CREMA 45X90 1A MT (1.62)****PARED ACRUX BEIGE 30.2X61  
1A MT.(2.60)****PARED ADARE BEIGE 30X60  
1A MT (1.44)****PARED ADARE ESTRU.  
BEIGE 30X60 1A (1.44)**





**PARED ALISIOS 30X60 1A MT. (1.62)**



**PARED ANTONELLA BLANCA BTE  
G36035B 30X60**



**PARED ARA BLANCO 30X45 1A MT. (1.51)**



**PARED ARCOIRIS AZUL CLARO 25X43  
MT(1.94)**



**PARED ARCOIRIS BLANCO 25X43  
MT. (1.94)**



**PARED ARKA BTE BLANCO 25000  
25X40 1A MT.**



**PARED ASTRO BLANCO 30X60  
1A MT. (1.62)**



**PARED BARY GRAY BTE  
30X45 MT (1.51) ALFA**



**PARED BERLIN BEIGE J3637A 30X60 1A MT.**

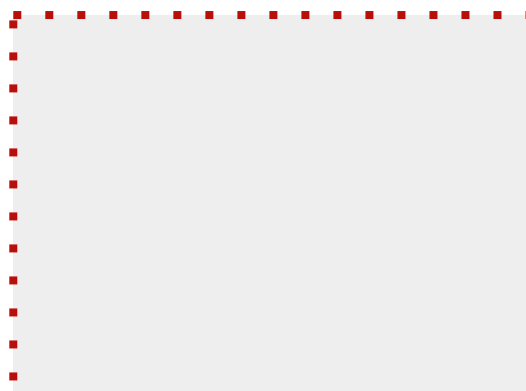

**PARED BERLIN CAFE J3637B  
30X60 1A MT.**



**PARED BLANCA MATE RECTIFIC.  
1A MT.(1.62)**

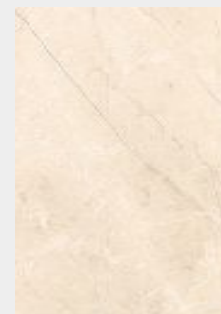

**PARED BONANZA CREMA  
37X59 1A MT(2.43)**



**PARED BTE MAR DEL PLATA BGE  
25X35 MT(2)**

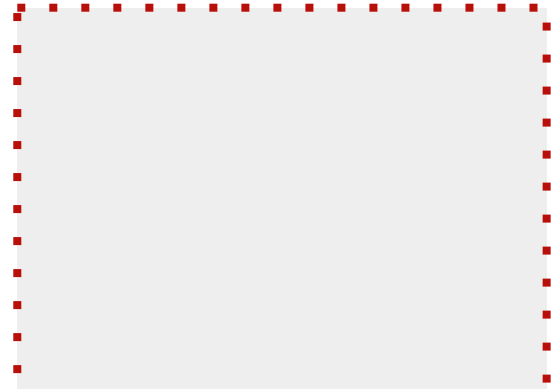

**PARED CADIZ BLANCO 37X59  
1A MT.(2.43)**



**PARED CHANTARELA GRIS  
30X45 1A MT.(1.89)**

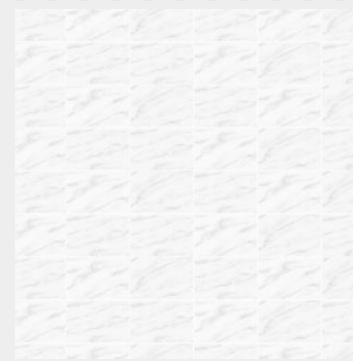

**PARED DUOMO BLANCO 30X45  
1A MT. (1.89)**



**PARED EGEO RBRO074A 25X40  
1A MT.(1.5)**



**PARED ESTRU ABRIL GRIS CLAR  
30X60 (1.44)**



**PARED ESTRU ABRIL GRIS OSCU  
30X60 (1.44)**



**PARED ESTRUCT ALCAIN BCO  
30X60 MT (1.44)**



**PARED ESTRUCT MAYARI GRIS  
25X43 1A(1.94)**



**PARED ESTRUCT TREVI BGE CD  
30X60 (1.44)**



**PARED ESTRUCT YARUMO MULT  
130X60 (1.44)**

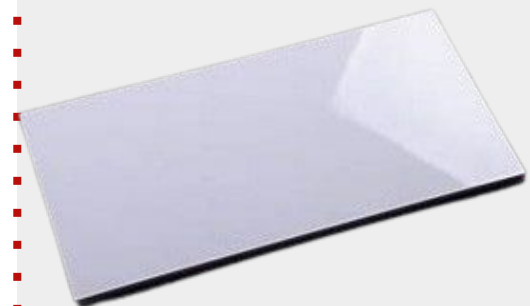

**PARED EVEREST 30600 30X60 (1.8)  
CASTEL**

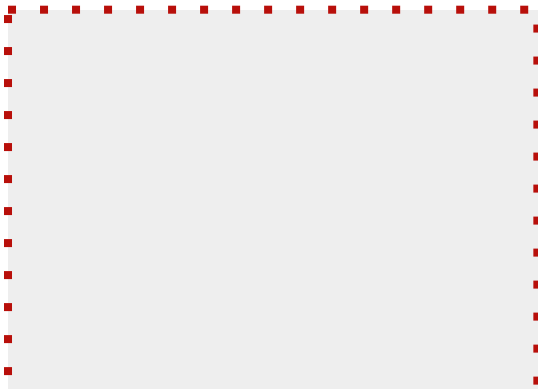

**PARED FIORELLA BLANCA BTE**  
G36041 30X60



**PARED FLORIDA BLANCO**  
37X59 1A MT(2.43)

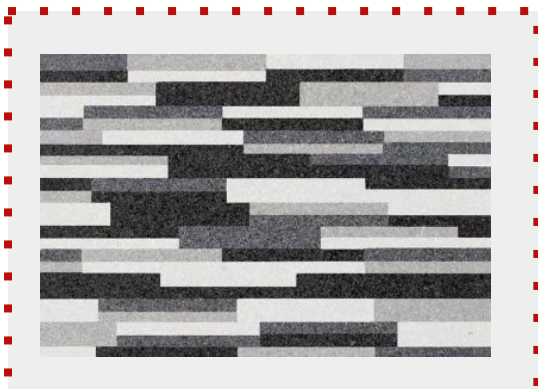

**PARED GETHI GRIS 30X45 1A**  
MT ALFA (1.51)

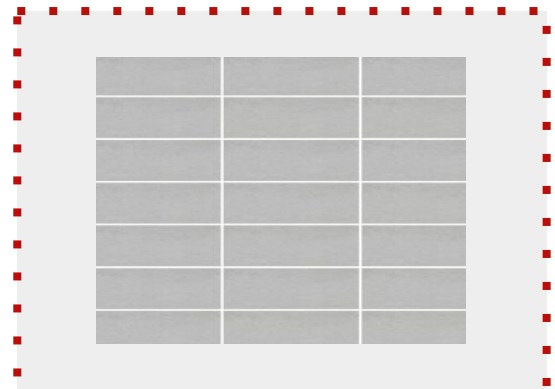

**PARED HARLEM GRIS 30X75**  
1A MT. (1.35)

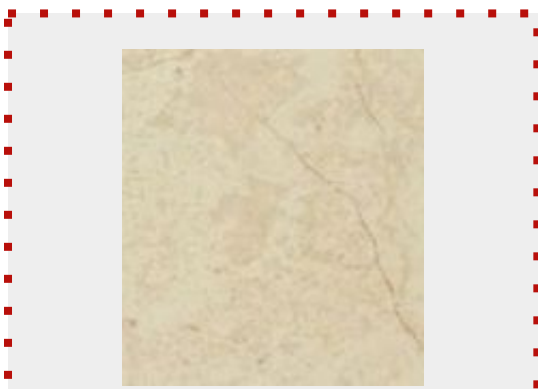

**PARED HUDSON RBR0060B 25X40 1A MT.**



**PARED IMPERIO BLANCA BTE**  
30X45 MT.(1.89)

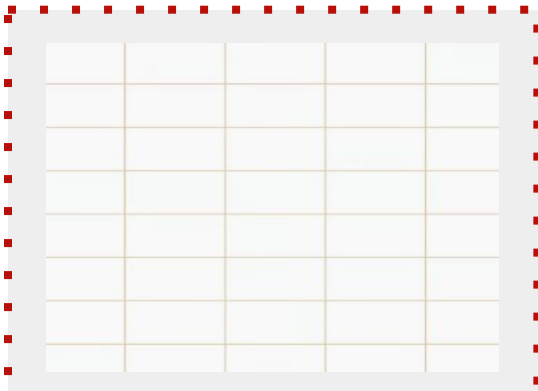

**PARED JAYA BLANCO 25X43  
1A MT. (1.94)**

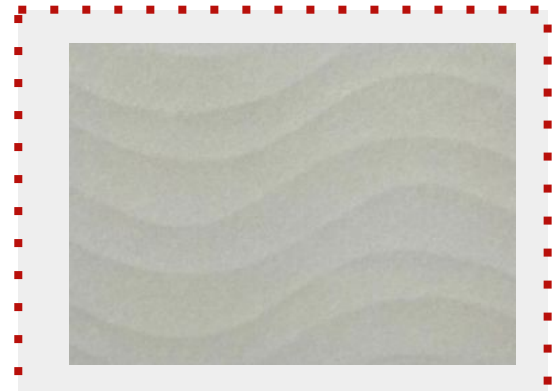

**PARED KAPPA TAUPE 30X45  
1A MT. (1.51)**

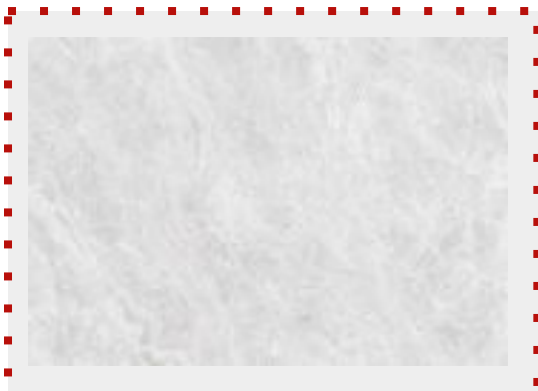

**PARED MANTIS GRIS CLARO  
30X45 MT. (1.89)**

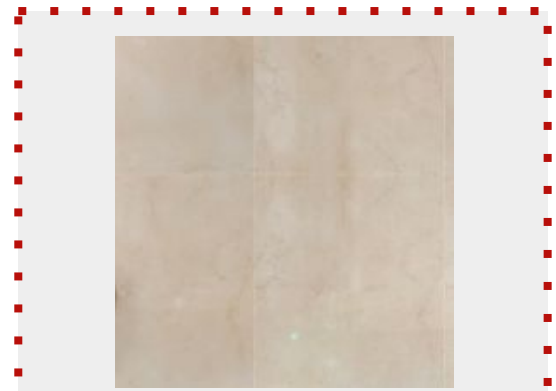

**PARED MARIA MARFIL MARMOLI BTE  
25X45 (2)**

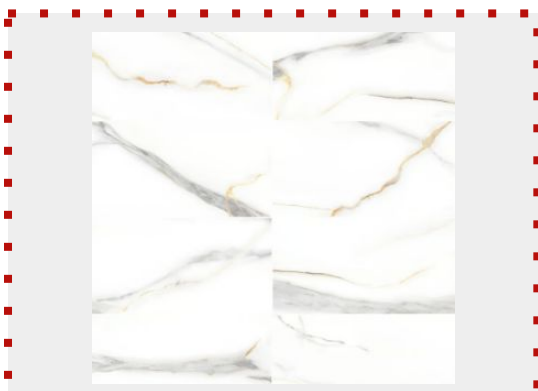

**PARED MARMOL ALBA 30X60  
1A MT (1.62)**

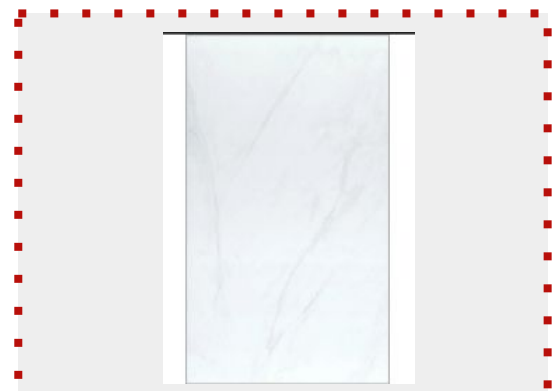

**PARED MARMOLIZ GAVEA CINZA  
33X57 (2.5)**



**PARED MARMOLIZADA KIANA  
GRIS CD 30X45 1A**



**PARED MARMOLIZ TREVI BEIGE CD  
30X60 1.44**

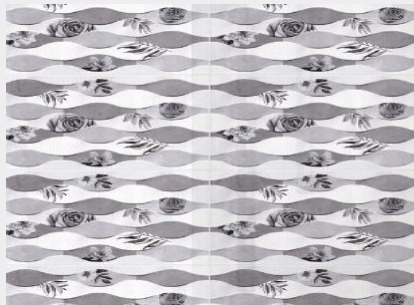

**PARED MODERNA COLORES GRISAM  
GRIS 25X43**

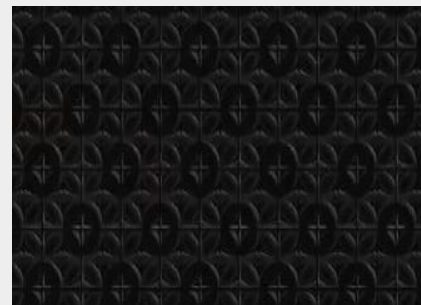

**PARED MONACO BLACK PLUS 0979  
31X60 1A MT**

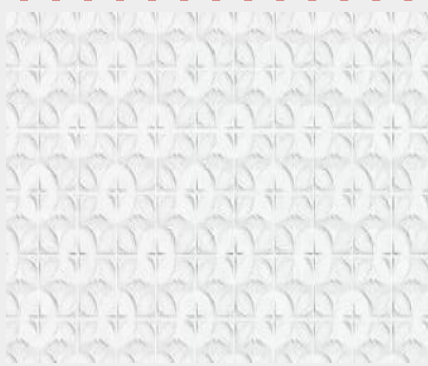

**PARED MONACO WHITE PLUS 0772  
31X60 1A MT**



**PARED MUCURA BEIGE 30X60  
1A MT CASTELLON**



**PARED MUCURA GRIS 30X60  
1A MT. CASTELLON**



**PARED NATU RIANA BEIGE 30X45  
1A MT(1.89)**



**PARED NATURAL GILI BEIGE CD  
30X45 1A MT.**

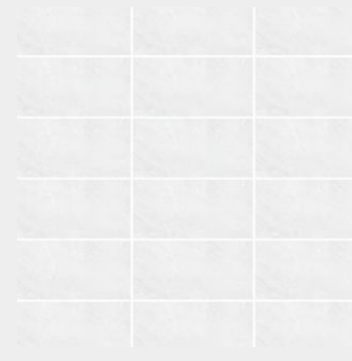

**PARED NAVIA GRIS CLARO CD  
30X60 MT(1.44)**

**PARED NEVADO BLANCO  
RECTIFICADA 30X60 1A**



**PARED NEXO AZUL BTE 30X45  
1A MT. (1.51)**



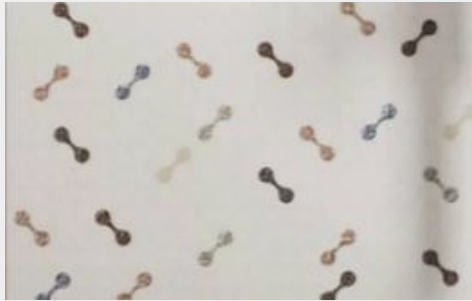

**PARED NEXO MULTICOLOR BTE  
30X45 1A MT.**



**PARED OASIS AZUL FRANCIA  
BTE 20X20 1A MT**

**PARED OASIS BLANCO BTE  
20X20 MT.(2) ALFA**

**PARED ONDAS BLANCO 36131  
30X60 MT (1.62)**

**PARED ESTRUC BURGOS MARFI 30x75 (1.35)**

**PARED PLANA EGEO BLANCO  
20x20 MT. (1.51)**

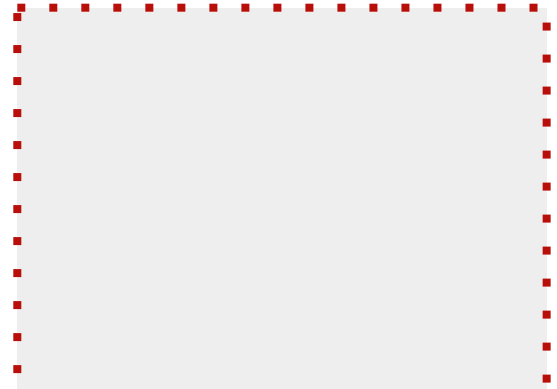
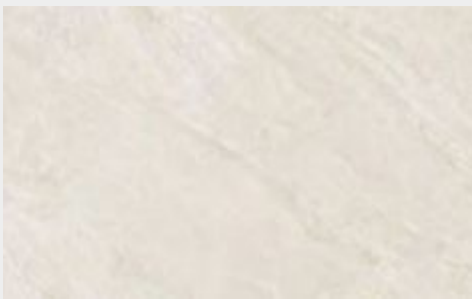
**PARED PROVIDENCIA 30.2X61 1A MT.****PARED RB6240A BALSATO  
CARRARA 30X60 1A****PARED RB8029A MALAGA BEIGE  
30X60 1A MT.****PARED ROMA BEIGE MARMOLIZ  
25X35 1A MT(2)****PARED SANTA MARIA MATE  
MULTI 30X45 1.89****PARED SANTORINI BLANCA 3611W  
30X60 1A MT**

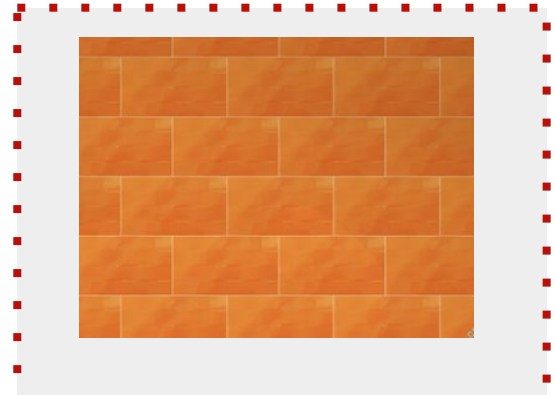
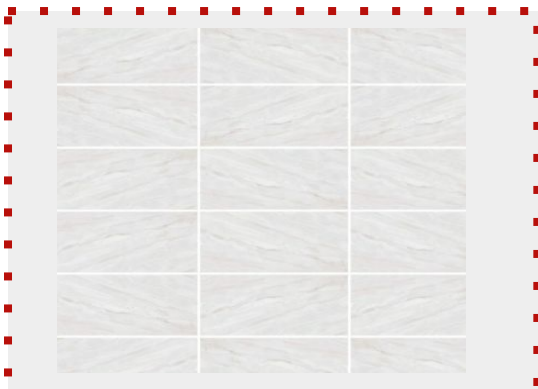
**PARED SLIM DECOR BLANCO 25X40 1A MT**

**PARED SLIM DUNAS NARANJA 25X40 1A MT**

**PARED TRANI BLANCO CD 30X60  
1A MT (1.44)**

**PARED VERSUS GRIS 30X75  
1A MT. (1.35)**

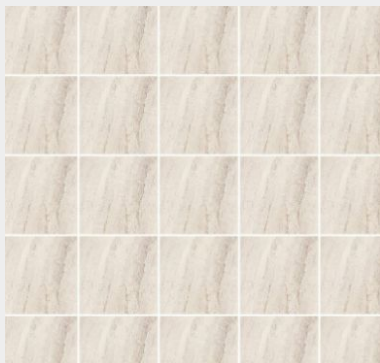
**PARED VINTAGE PRATA 33X57  
TU CASA MT(2.5)**

**PEDESTAL MANANTIAL BLANCO**

**PEDESTAL VERONA/MILANO BLANCO 100****PELDAÑO BEIGE CORONA****PELDAÑO MARFIL BTE 33X6X5  
INTERMATEX****PELDAÑO NEGRO SATINADO 33X6X5****PISO AIRA BEIGE 55X55 1A MT. (1.52)****PISO ALISO HUMO 51X51 1A MT (2.34)**

**PISO ALOE BEIGE 60X60 1A MT. (1.8)**

**PISO AMAZONAS BEIGE 50X50  
1A. MT. (2.50)**

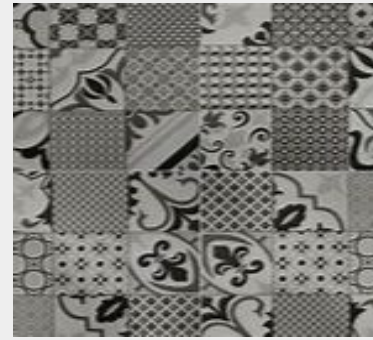
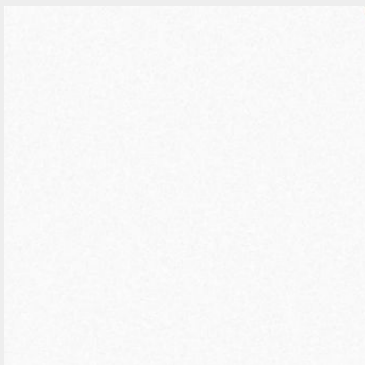
**PISO ANDARAI 50X50 1A MT (2.50)**

**PISO ANDROMEDA GRIS 61X61 1A MT.**

**PISO AQUA BLANCO 30X30  
1A MT ALFA (1.86)**

**PISO ARIETA 60X60 1A. MT. (1.80)**



**PISO ARTICA BLANCO 61X61  
MT ALFA (1.86)**



**PISO AVILA BEIGE BTE 61X6  
11A MT (1.86)**



**PISO BELAIRE DUROPISO GRIS  
55X55 1A MT.**



**PISO BELAIRE MARFIL DUROPISO  
55X55 1A MT**



**PISO BONANZA CREMA CM201  
54X54 MT (2.62)**



**PISO BOTICCINO BLANCO 61X61  
1A MT.(1.86)**



**PISO CASTANO MULTICOLOR  
60X60 1A MT(1.8)**



**PISO CENTAURO TABACO 61X61 1A MT. (2.2)**



**PISO CORUNA MULTICOLOR  
45X45 1A MT(1.89)**



**PISO CREMA MARFIL 61X61 1A MT (2.23)**



**PISO DEVA CAFE 33X33 1A MT. (1.6)**



**PISO DRACO TAUPE 55X55 1A MT. (1.52)**

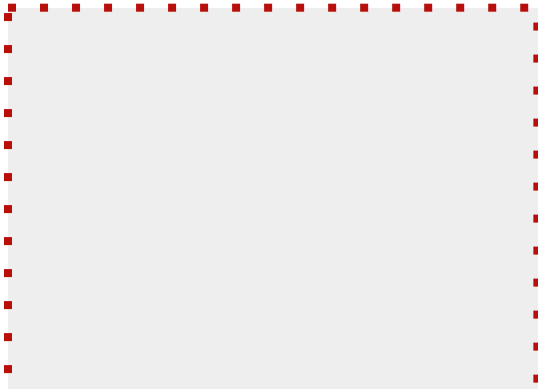

**PISO EMPEDRADO GAYRA**  
45439 45X45 (2.25)

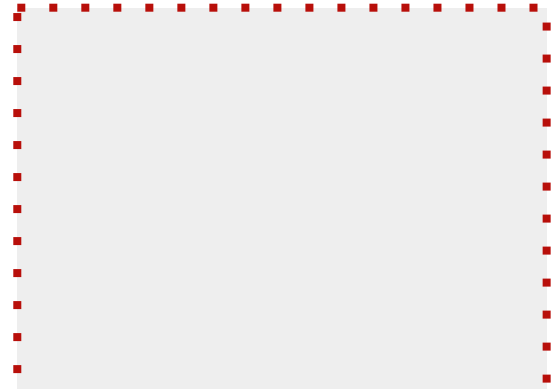

**PISO ESTELAR AZUL CLARO**  
30X30 MT. (1.86)

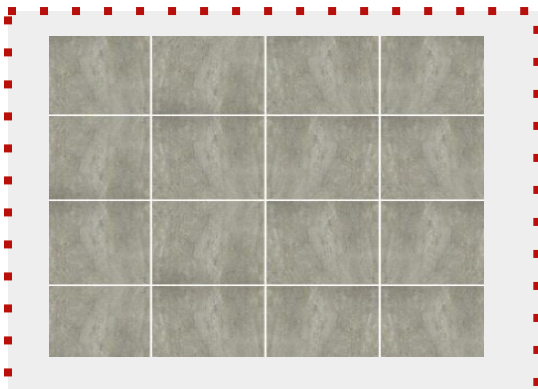

**PISO ESTRUC VOSGOS CAFE**  
60X60 1A MT(1.8)



**PISO EUCALIPTO GRIS 55X55**  
1A MT. (1.52)

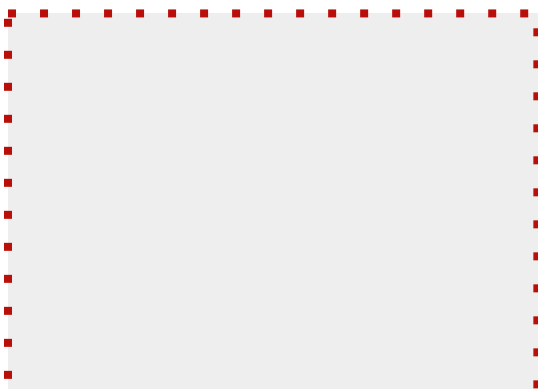

**PISO EXTERIOR DELFOS 43169**  
43X43 1A MT.

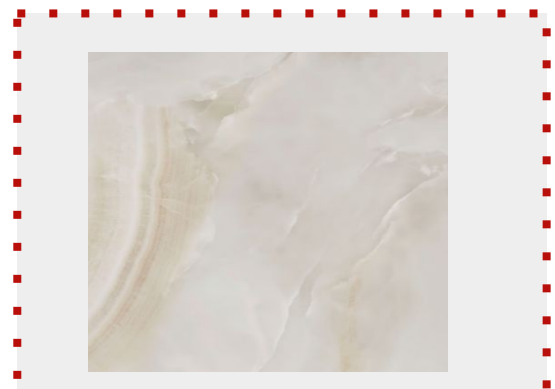

**PISO EXTERIOR DURANGO**  
57008 57X57 1A MT.





**PISO EXTERIOR SINU NATURAL**  
1A MT. (2.34)

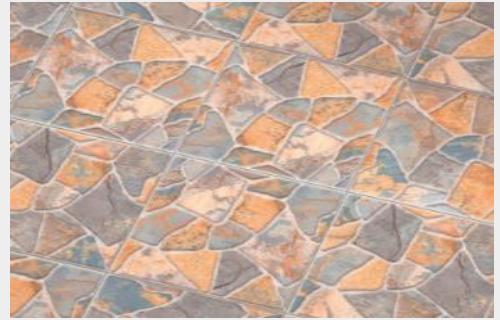

**PISO EXTERIOR TANGER**  
45X45 MT ALFA(1.82)



**PISO EXTERIOR VIA CONDOTT**  
I 57203 57X57



**PISO GALO MULTICOL CD 55X55**  
1A MT(1.52)



**PISO GALO MULTICOLOR**  
45X45 1A MT (1,89)



**PISO HIDRAULICO COLONIAL**  
MULTI. 20X20



**PISO HIDRAULICO PORTUGALIA  
AZUL 20X20 1A**



**PISO HONDA BEIGE 51X51 1A MT. (1.82)**

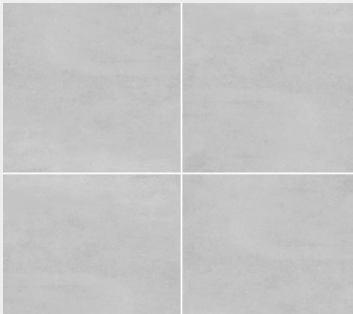

**PISO ITRIA GRIS MATE 60X60  
1A. MT (1.80)**

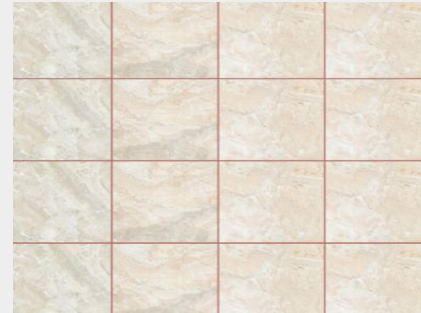

**PISO LAIKA BEIGE 60X60 1A MT.(1.8)**

**PISO MADERA CABIN CAFE CD  
55X55 MT(1.52)**



**PISO MADERA CABIN GRIS CD  
55X55 MT(1.52)**



**PISO MADERA LEÑO PAMPA  
51X51 1A MT.(2.34)**

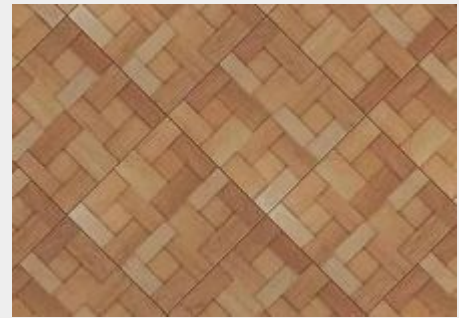

**PISO MADERA MURCIA MIEL  
45X45 1A MT.**



**PISO MADERA NIAGARA GRIS CD  
60X60 MT.(1.8)**



**PISO MANCORA ARD CAFE 33X33  
1A MT.(1.6)**



**PISO MANTELLO 30X60 1A MT. (1.62)**



**PISO MARMARA GRIS 60X60 1A MT.(1.8)**

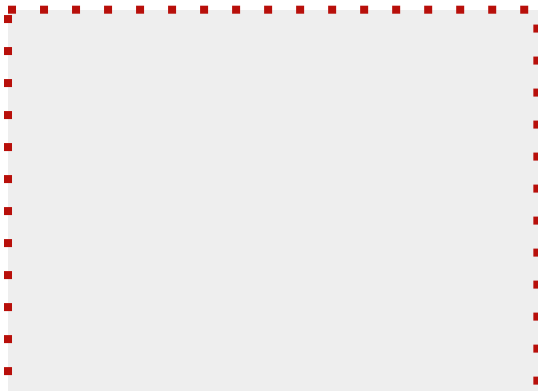

**PISO MARMOLIZADO RECT  
HAMILTON 6047B6252**

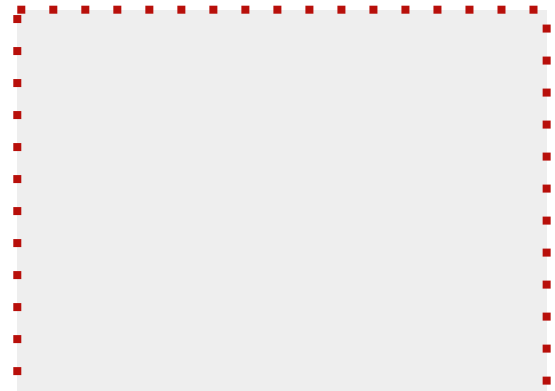

**PISO MARMOLIZADO RECT  
. RANSEY 60476H051**

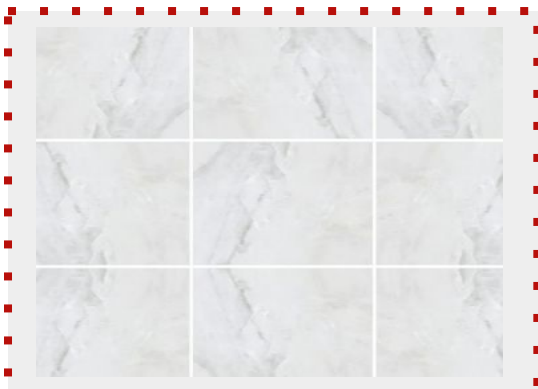

**PISO MENORCA GRIS CD 60X60 1A MT.(1.8)**

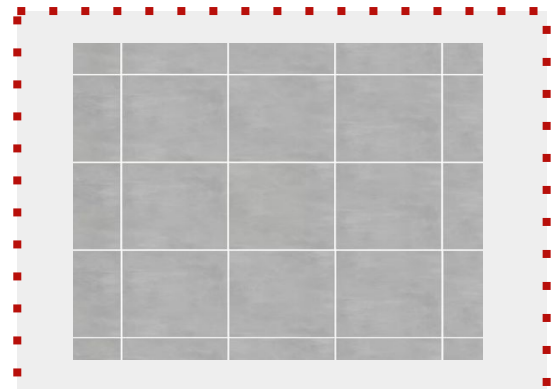

**PISO METROPOLI GRIS 60X60 1A MT.(1.8)**

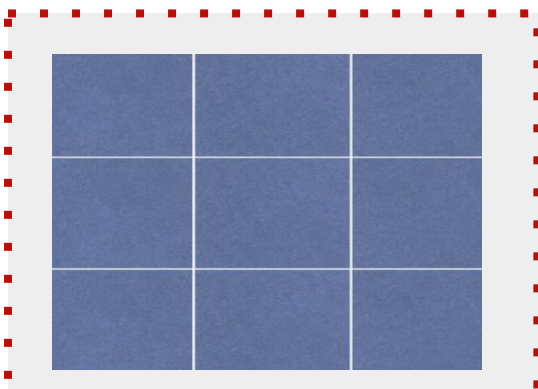

**PISO MIKONOS ARD AZUL 33X33 1A MT.(1.6)**



**PISO MIKONOS ARD BEIGE 33X33 1A MT (1.6)**

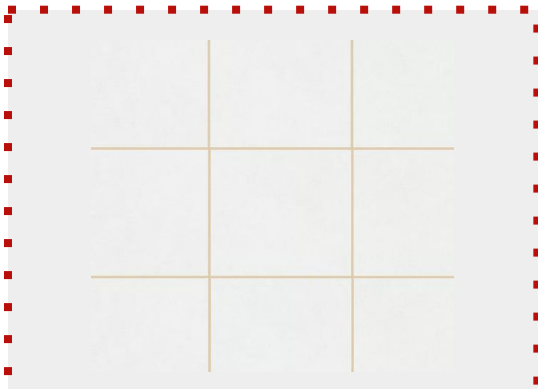

**PISO MIKONOS ARD BLANCO**  
33X33 1A MT(1.6)

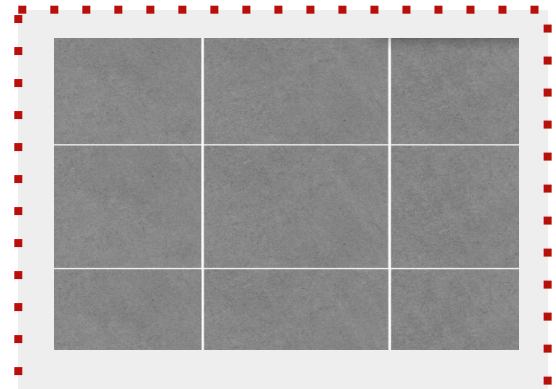

**PISO MIKONOS ARD GRIS**  
33X33 1A MT. (1.6)

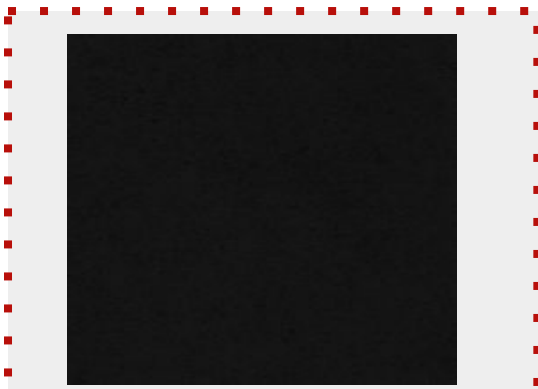

**PISO MIKONOS ARD NEGRO**  
33X33 1A MT (1.6)

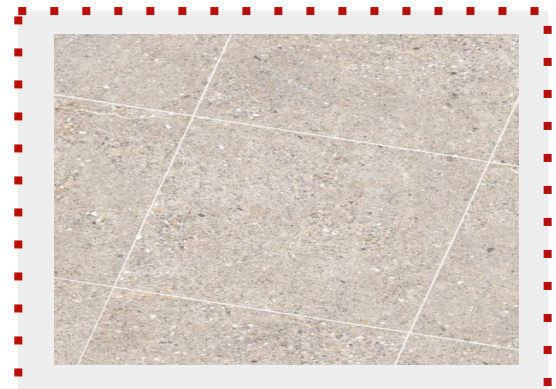

**PISO MUTIS SKERPAS 51X51 1A MT. (2.34)**

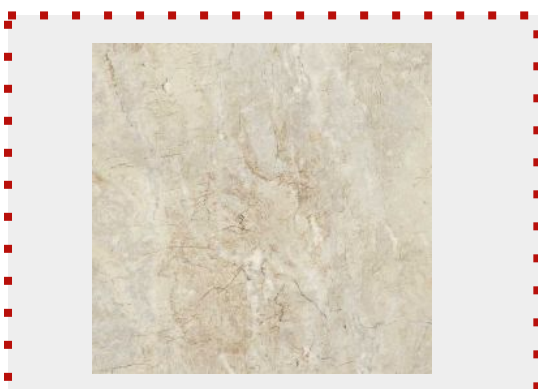

**PISO NATURAL PIEDRA DEL**  
**SOL BEIGE 55X55**



**PISO NATURAL VANCOUVER**  
**HIELO 60x60 1A MT**



**PISO NAZCA MULTICOLOR  
55X55 1A MT (1.52)**



**PISO NUTIBARA BEIGE 51X51  
1A MT. (2.34)**



**PISO NUTIBARA GRIS 51X51 1A MT. (2.34)**

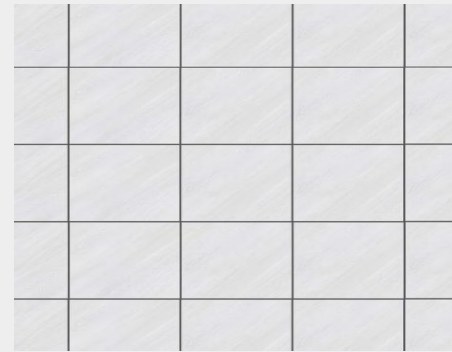

**PISO OLMO HIELO 55X55 1A MT. (1.52)**



**PISO OVIEDO CAFE CD 55X55 1A MT. (1.52)**

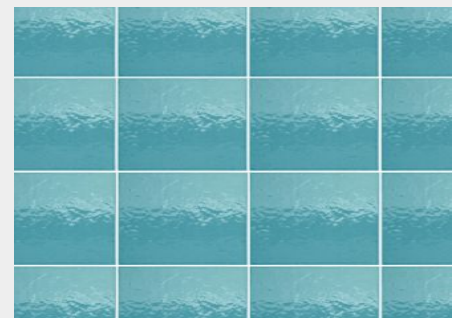

**PISO PARED ADRIATICO  
AGUAMARINA 20X20**



**PISO PARED ADRIATICO AZUL  
OSCURO 20X20**

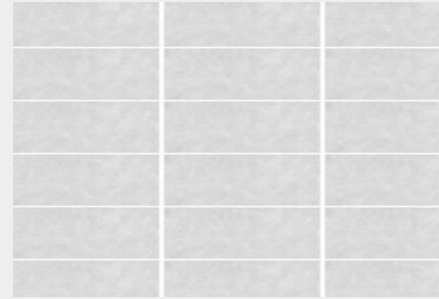

**PISO PARED ARABIA ARD GRIS  
CD 30X60 1A**



**PISO PARED AS BLUE 30X30 MT.(0.99)**



**PISO PARED AS GRAY 30X30 MT.(0.99)**

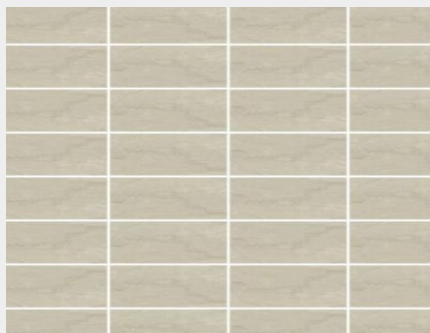

**PISO PARED CALACOA BEIGE CD  
30X60 1A MT.**



**PISO PARED ECO PLUS BLANCO  
20X20 1A MT.**



**PISO PARED MANDALA  
MULTICOLOR 20X20 UNID**

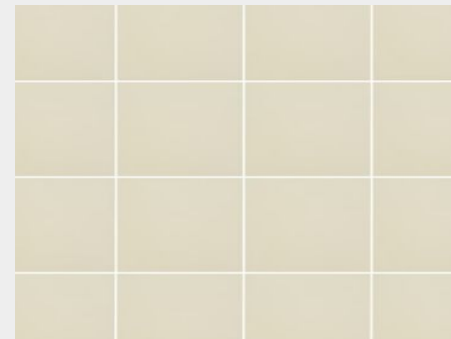

**PISO PARED NATAL BEIGE  
20X20 1A MT(1.51)**



**PISO PARED NATAL BLANCA  
30X60 MT. (1.62)**



**PISO PARED RECT BILBAO  
BEIGE 41X90 1A MT**



**PISO PARED TAHOE AZUL  
24X24 1A MT(1.54)**



**PISO PATAGONIA BLANCO  
51X51 1A MT (2.34)**





**PISO PIEDRA COLOMBIA OXIDO  
30X30 1A MT.**



**PISO PIETRA EXTERIOR 30X30  
MT(1.86) ALFA**



**PISO PISCINA BALI OCEAN 30X61  
MT. (1.30)**



**PISO REC ABETO GRIS 20X90 1A MT. (1.08)**



**PISO RECTIFI ALAMO BEIGE 20X90  
MT(1.08)**



**PISO ROCCA BEIGE 30X30 1A MT.  
ALFA (1.86)**



**PISO ROCCA GRIS 30X30 1A MT. ALFA (1.86)**



**PISO SABINA CAFE 45X45 1A MT.(1.89)**



**PISO SAMUI CAFE 51X51 1A MT.(1.82)**



**PISO SANTA CATALINA BTE 51X51 1A MT**



**PISO SANTO TOMAS BTE 51X51 1A MT**



**PISO SIENA CREMA MATE 45X45  
1A MT (1.42)**

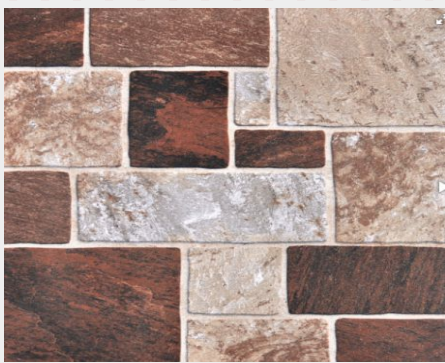

**PISO SLAB EXTERIOR 30X30 MT. ALFA (1.86)**

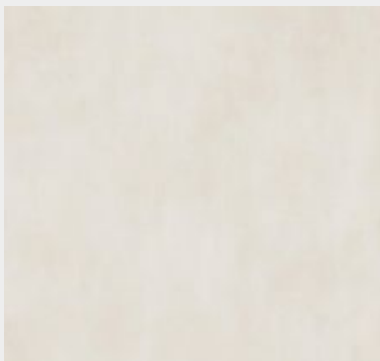
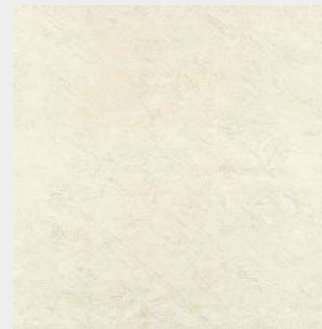
**PISO STONE BLANCO 45X45  
1A MT (1.82)ALFA**

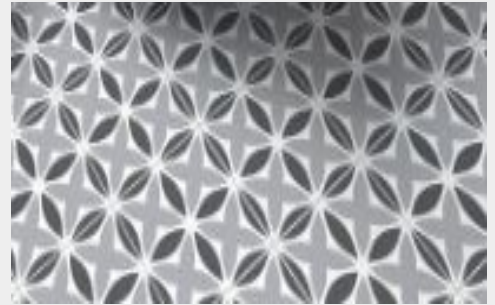
**PISO TOLU 51X51 1A MT. CASTELLON (2.10)**

**PISO TRAFFIC STONE ADZ MARRON  
54X54 1A**

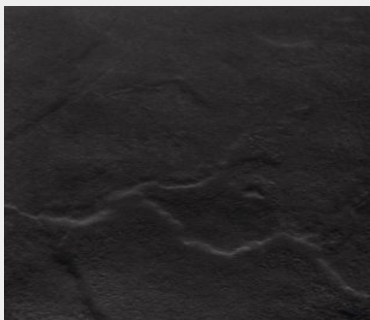
**PISO VANCOUVER BEIGE 60x60 1A MT. (1.8)**

**PISO VENATO BEIGE 57X57 1A MT (3.30)**

**PISO VOLTERRA PLUS 45X45 1A MT.**

**PISO-PARED ARGENTA ELIPSE  
NEGRO 30X30 1A**

**PISO-PARED TERRE DECO  
MULTI 30X30 1.31**

**PIZARRA BLANCA 30X30  
1A MT. ALFA (1.86)**

**PIZARRA NEGRA 30X30  
1A MT. ALFA (1.86)**

**PORCEL BEIGE MATE TRAVER  
60X60 MT.(1.44)**



**PORCEL PLANO ARTIK BCO**  
56X56 1A MT.(1.6)



**PORCEL RECT CALIZA MARFIL**  
40X88 MT(1.06)



**PORCEL RECT. CALIZA GRIS**  
40X88 MT.(1.06)



**PORCELAN ADARA GOLD BLANCO**  
BL1153 60X60

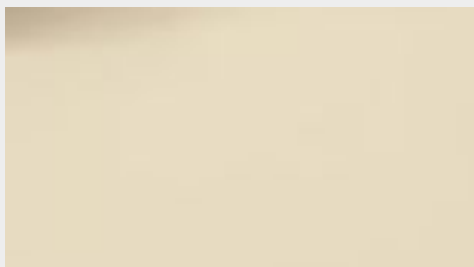

**PORCELAN BEIGE PLANO 60X60**  
1A MT (1.44)



**PORCELAN BEIGE PULIDO**  
ESMALTADO HW0061



**PORCELAN BELFORT CARAMELO**  
24X1,20 1A MT

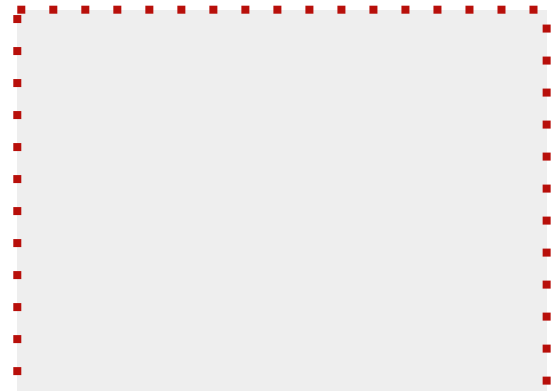

**PORCELAN GRAMERCY BROWN**  
22 X 1.20 (1.61)



**PORCELAN GRIS BTE RECTIF**  
60X60 6012PC003

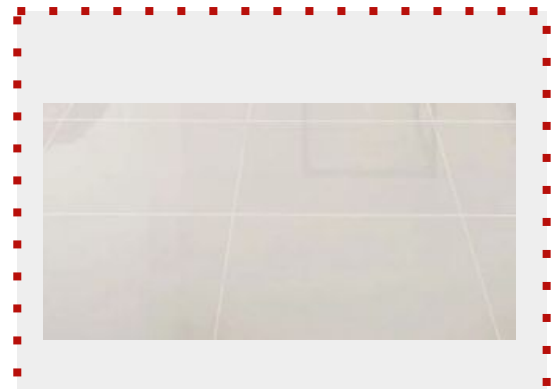

**PORCELAN ONIX BEIGE 60X60**  
1A MT. (1.44)

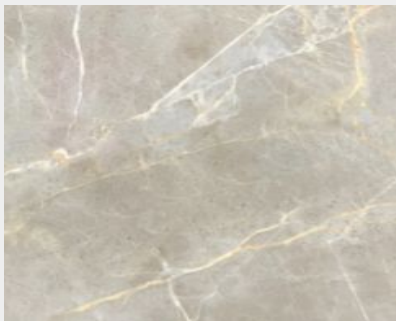

**PORCELAN PIETRA REALE**  
GRIS OSCURO GS864

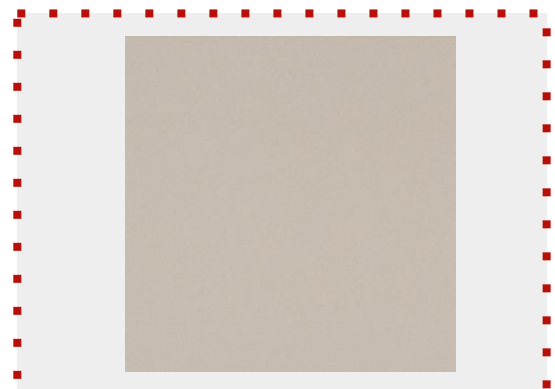

**PORCELAN PLAIN PLUS BEIGE**  
BE994 60X60 1A

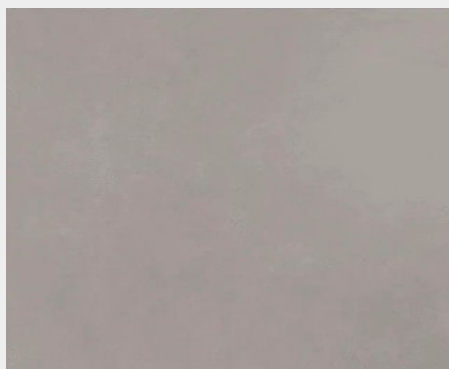

**PORCELAN PLANET GRIS PM36A09**  
60X60 1A MT



**PORCELAN RECT ESTRUCT ESCOCIA**  
CAFE 20X88



**PORCELAN RECT. NORDIK GRIS**  
24X1.20 1A MT



**PORCELAN SAMARA CANELA**  
NL937 60X60 1A MT

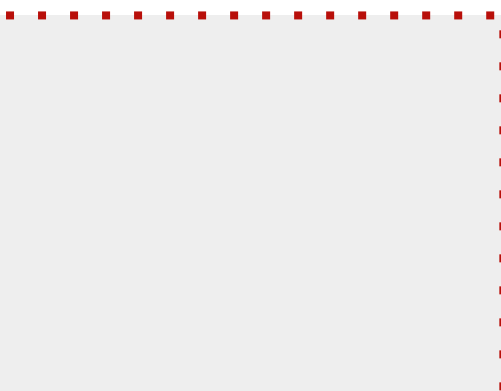

**PORCELAN SANTORINI XHL**  
15013 75X1,50 1A

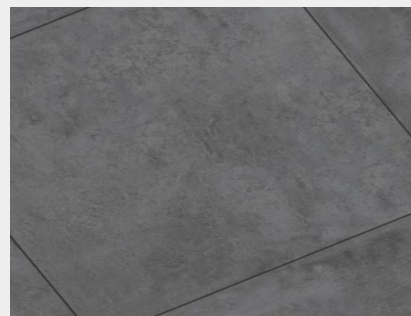

**PORCELAN SHADOW DARK**  
60X60 1A MT. (1.8)



**PORCELAN SUPER BLANCO  
ALASKA Y61000**

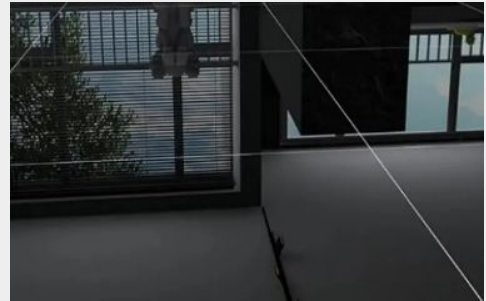

**PORCELAN SUPER NEGRO BTE  
RECT 601216926B**

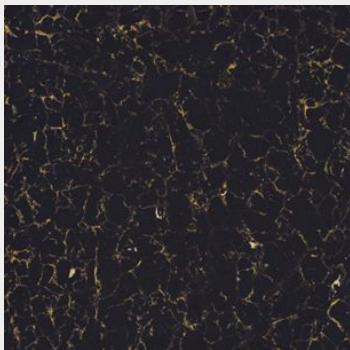

**PORCELAN THUNDER NEGRO  
NG969 60X60 1A MT**



**PORCELAN VECIA BEIGE 66X66  
1A MT.**



**PORCELAN VECIA CINZA  
GRAY 66X66 MT.**

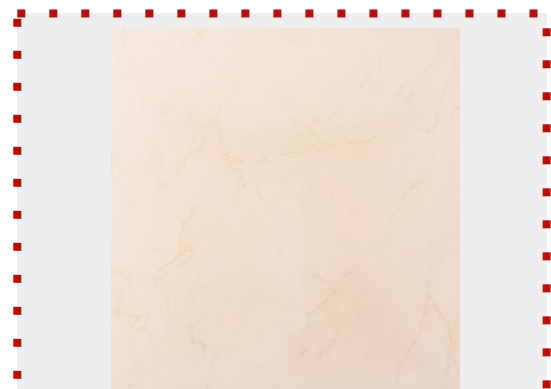

**PORCELANA GIL Y PLUS BEIGE BTE 60X60**





**PORCELANATO ARENA BEIGE  
BTE RECTIFICADO**

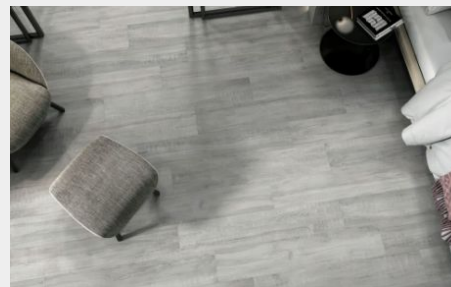

**PORCELANATO ATENAS TT-660223  
60X60 1A MT**

**PORCELANATO GRAMERCY  
CREAM 22 X 1.20 MT**

**PORCELANATO IBIZA 60X1.20  
INTERMATEX 1A**

**PORCELANATO MADERA  
CAFE ESMALTADO XP 104**

**PORCELANATO MADISON  
22X1.20 1 A MT(1.61)**



**PORCELANATO MAPLE BEIGE**  
**SD8813 60X60 1A**

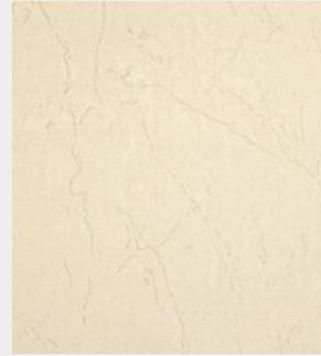

**PORCELANATO NAPOLES BEIGE**  
**36036Z 60X60**



**PORCELANATO PULPYS GREY**  
**60 X 1.20 (1.44)**



**PORCELANATO RIVERA ONYX**  
**60X120 1A MT.**



**PUNE MULTICOLOR 20x20 UND**



**SALDOS LISTELLOS**



**SANITARIO BURGOS ALONGADO  
BLANCO**



**SANITARIO CIMA ALONGADO**



**SANITARIO ELEGANCE BLANCO  
2109 TU CASA**



**SANITARIO FONTANA ALONGADO  
BLANCO TC**



**SANITARIO FUSSION ALONGADO BLANCO**



**SANITARIO GRANADA BLANCO ITALIA**



**SANITARIO HAPPY BEIGE**



**SANITARIO HAPPY BLANCO**



**SANITARIO KAEL BLANCO DG**



**SANITARIO LAGUNA AZUL CLARO 111**



**SANITARIO LAGUNA BEIGE 103**



**SANITARIO LAGUNA BLANCO 100**



**SANITARIO LAGUNA VERDE CLARO 141**



**SANITARIO LAZIO BLANCO ITALIA**



**SANITARIO MANANTIAL BEIGE 103**



**SANITARIO MANANTIAL BLANCO**



**SANITARIO MONTECARLO  
ALONGADO BLANCO 100**



**SANITARIO MONTECARLO  
NOVO REDONDO BONE**



**SANITARIO MUKURA ALONGADO  
BLANCO**



**SANITARIO ONE PIECE ALONGADO  
LUXOR**



**SANITARIO ONE PIECE MONACO  
BLANCO ALFA**



**SANITARIO ONE PIECE PALERMO  
BLANCO ROMA**



**SANITARIO SMART ALONGADO BEIGE**



**SANITARIO SMART ALONGADO BLANCO**



**SANITARIO SMART REDONDO BLANCO**



**SANITARIO TWO PIECE ROCKET BLANCO**



**SANITARIO VENERO BLANCO TC**



**SAVELLI 60X60 1A MT.(1.80)**



**SEMPIPEDESTAL HAPPY BLANCO 100**



**SENDA TERRA 30X60 1A MT. (1.62)**

**SEUL BLANCO 45X45 1A MT. (1.82) ALFA****SEVILLA REAL 60X60 1A MT. (1.80)****SPADA BEIGE 60X60 1A MT(1.8)****SPADA BLANCO 30X60 1A MT.(1.62)****SPADA BLANCO 60X60 1A MT. (1,80)****STALLETI NATURAL 30X60 1A MT. (1.62)**





**SURAT MULTICOLOR 20x20 UND**



**TACO CADIZ BLANCO 6X6**



**TAPA TANQUE LAGUNA BLANCO  
SIN GRIFERIA**



**TERZI 60X60 1A MT. (1.80)**



**TIBER MARE 30X60 1A MT. (1.62)**



**TOLEDO MULTICOLOR 20x20 UND**



**TORMES 58x1.18 1A MT (2.07)**



**TRENTINO 60X60 1A MT. (1.80)**



**TRENTINO 60X60 2DA MT. (1.80)**



**TRIVENTO HUMO 25X75 1A MT (1.50)**



**TRIVENTO TERRA 25X75 1A MT (1.50)**



**TURCHI 19X1.18 RECTIFICADO  
1A MT.(1.14)**

**UMBRIA 45X90 1A MT (1.62)**

**VALTELINA 58X1.18 1A MT. (2.07)**

**VULCANO BEIGE 60X60 1A MT.(1.80)**

**VULCANO GRIS 60X60 1A MT.(1.80)**

**ZABLE BLANCO 60X60 1A. MT. (1.80)**

**ZAFIRO 45X90 1A MT. (1.62)**



**ZARAGOZA MULTICOLOR 20x20 UND**



**PISO ESTRUC MONTESOL CAFE  
20X92 1A MT.**



**PISO PARED HEX HIERBABUENA  
MULT 23X26 CJ**



**PISO PARED HEX CEMENTO  
GRIS 23X26 1A CJ**



**PISO PARED HEX CELTA MULTI  
23X26 1A CJ**

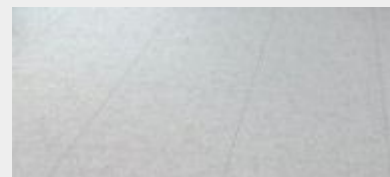

**SANITARIO CELTA BLANCO ITALIA**

**SANITARIO SENA BLANCO ITALIA****SANITARIO TAMESIS NEGRO MATE ITALIA****PISO MADEIRA DHARANA  
GRIS 20X92 1A(1.14)****PISOPORCE EST SOLARI NATURAL  
24X119 1.42****BASE DECORADA BOTANICA  
MULTI 30x60(1.44)****PISO DUROPISO BLANCO 51X51 (1.82)**

**SANITARIO OP ALONGADO HEBE STRETTO**

**SANITARIO ELEGANCE IVORY TU CASSA**

**SANITARIO ELEGANCE NEGRO TU CASSA**

**FACHADA VIGO AMBER 30X60  
TU CASSA (0.9)**

**FACHADA VIGO SLATE 30X60  
TU CASSA (0.9)**

**FACHADA COLORADO CREMA  
30X60 TU CASSA**

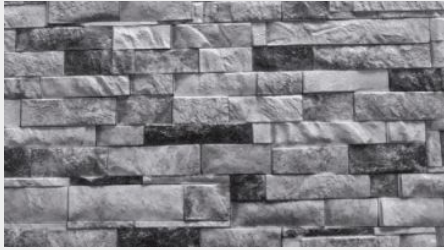

**FACHADA LATVIA GREY 30X60  
TU CASSA (0.9)**



**PARED BLANCA 360W 30X60  
TU CASSA (1.44)**



**LAVAMANOS POMPEI BLANCO TU CASSA**



**LAVAMANOS PRIME NEGRO  
53X46 TU CASSA**

**PORCELAN BLANCO PLANO  
60X60 JC6200 1.44**

**PARED KENNET MARMOL BCO 32X58 (2.02)**

**LISTELLO TREBOL ROJO 8X25****LISTELLO SF-49 5X20****MALLA CRISTAL MOSAI VID  
TIKAR BGE 30X30****BASE DECORADA DANZA  
ARABE 30X45 UNID****LAVAMANOS OLIMPIA BLANCO DM****LAVAMANOS TRIPOLY B11  
INCRUS BLANCO DM**





**LAVAMANOS ROMA REDONDO  
BLANCO 36X36 DM**



**LAVAMANOS MILLAN SLIM BLANCO DM**



**MONFERRATO GRIS 60X60 1A MT. (1.80)**



**PARED PLANA BURGOS MARFI  
30x75 (1.35)**



**SANITARIO KIDDY ECOFLUSH BLANCO**



**SANITARIO KIDDY ECOFLUSH BICOLOR**

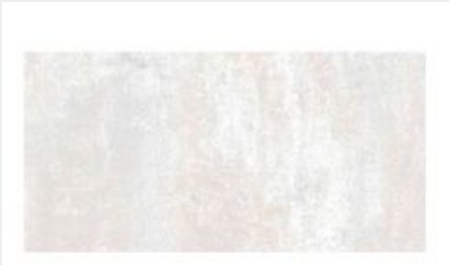
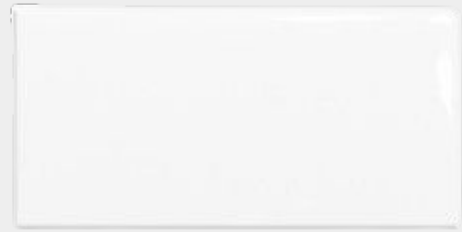

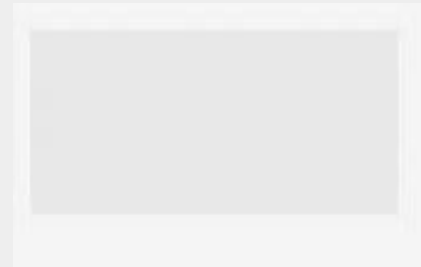
**PARED RECT 63115 BLANCO 30X60 (1.62)**

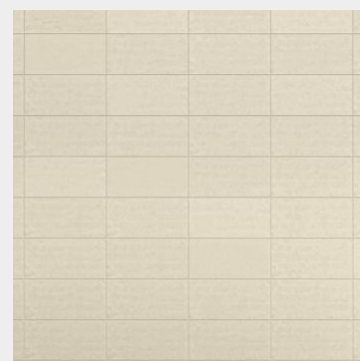
**PARED RECT 8347 BLANCO 30X60 (1.62)**

**PARED RECT MBJ01 BCO/BGE 30X60 (1.62)**

**PARED REC EST. 63111 BLANCO 30X60 (1.62)**

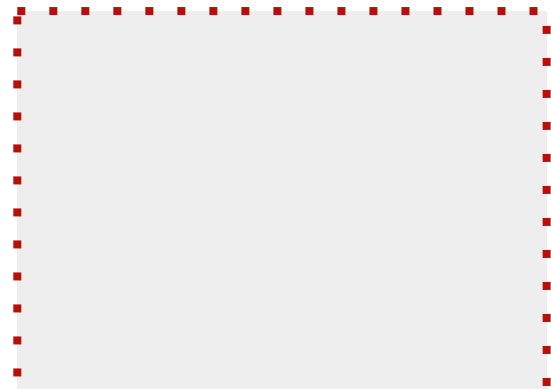
**PISO TERRA EXTERIOR BEIGE 61X61 (1.86)**

**PISO PARED NORDICO BEIGE 30X60 (1.28)**

**PARED MARMOL IMPERIO GRIS 30X60 (1.28)**

**PISO PARED TRAVERTINO  
MARFIL 30X45 1.51**

**PARED ESTR ONDAS BLANCO  
25X70 MT (1.58)**

**PARED ESTRUC 25415B NEGRO  
25X40 1.50**

**PISO BELAYA BEIGE 51X51 1A MT. (1.82)**

**PISO BELAYA GRIS 51X51 1A MT. (1.82)**



**ORINAL PETITE CON GF DE PORCELANA**



**LADRILLO VEZZIO BEIGE  
60X60 MT (1.8)\*\*\***

# GRIFERÍA

- Duchas 203
- Desagües 207
- Ducha Electrica 211
- Grifos - incrustaciones 214
- Kits - Llaves 218
- Mezcladoras y Regaderas 237
- Registros - Repuestos 248
- Toalleros - Válvulas 252

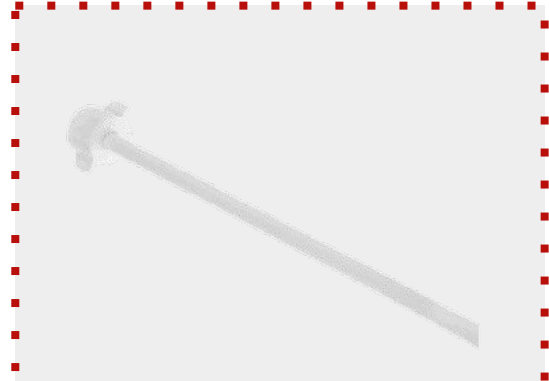

**ACOPLE LAVAMANOS 40CMS PCP****ACOPLE LAVAMANOS LAVAPLATOS 10020****ACOPLE SAN. CON VAL REG 10023 PAVCO****ACOPLE SANITARIO 10024 PAVCO****ACOPLE SANITARIO 40CMS PCP****AGUA STOP FLAPPER ADVANCE O2345**

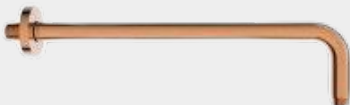
**GRIVAL****AHORRADOR DIRIGIBLE 021660 GRIVAL****GRIVAL****BRAZO REGADERA 92402 GRIVAL****BRAZO REGADERA A PARED LOFT NEGRO****BRAZO REGADERA A PARED URBAN 40CM  
DORADO****BRAZO REGADERA A PARED URBAN 40CM  
ROJO****GRIVAL****BRAZO REGADERA IRON LARGO IR400  
GRIVAL**

**GRIVAL****BRIDA SANITARIA 73760/73762 GRIVAL****CANAST LAVAPLATOS + SIFON P  
93530-93518L****CANASTILLA 4" METALICA CON SOSCO  
93726**

**GRICOL**
**CANASTILLA LAVAPLATOS 4 01-1951-11  
GRICOL****GRIVAL****CANASTILLA LAVAPLATOS 4 93503 GRIVAL****Gerfor****CANASTILLA LAVAPLATOS 4" 101074  
GERFOR**



**PAVCO**

**CANASTILLA LAVAPLATOS 4.1/2  
TRAMONTINA**



**CANASTILLA PLASTICA 4 10596 PAVCO**

**GRIVAL**

**CARTUCHO PARA FILTRO 1 ETAPA 79746  
GRIVAL**

**GRIVAL**

**CARTUCHO PARA FILTRO 2 ETAP. 797475  
GRIVAL**

**GRIVAL**

**CARTUCHO PARA FILTRO 4 ETAP 79781  
GRIVAL**

**GRIVAL**

**CHEQUE 179717 GRIVAL**

**GRIVAL**



**CHEQUE 1/2 79715 GRIVAL**

**GRIVAL**



**CHEQUE 1/2 79718 VERTICAL RESORTE GRIVAL**

**GRIVAL**



**CHEQUE 3/4 79716 GRIVAL**

**GRIVAL**



**CHEQUE COMPACTO 1/2 79911 GRIVAL**

  
**GRICOL**



**CONJUNTO DUCHA 01-1534-11 GRICOL**

**GRIVAL**



**CONJUNTO DUCHA ALUVIA AV405 PALANCA GRIVAL**

**GRIVAL**

**CONJUNTO DUCHA ALUVIA AV406  
CRUCETA GRIV**

**GRICOL**

**CONJUNTO DUCHA ATLAN. 01-1334-11  
GRICOL**

**GRIVAL**

**CONJUNTO DUCHA BALTA BL403 PCA  
CUAD GRIVAL**



**CONJUNTO DUCHA BRIZA  
32460-32461-32463**

**GRICOL**

**CONJUNTO DUCHA KRISTHAL 01-1134-00  
GRICOL**

**GRIVAL**

**CONJUNTO DUCHA SENC ARCE CUAD  
RC400 GRIVAL**

**GRIVAL**
**CONJUNTO DUCHA SENCILLA NOGAL  
43430 GRIVAL**

**CONJUNTO DUCHA TELEFONO ANT**
**GRICOL**
**CONJUNTO GRIFERIA SANIT  
SA-1907-11GRICOL**
**GRICOL**
**CONJUNTO LLAVE LAVAMANOS 1301-11  
GRICOL**
**GRIVAL**
**CONJUNTO LLAVE LAVAMANOS NOGA  
54113 GRIVAL**

**CONJUNTO LLAVE LAVAPLATOS AV502  
ALUVIA**

  
**GRICOL**

**CONJUNTO MEZ. LAVAMANOS 01-1805-11  
GRICOL**

  
**GRICOL**

**CONJUNTO MEZC LAVAMANOS 4  
01-0813-11GRICOL**

**CONJUNTO MEZCLA. LAVAMANOS 4 AV101  
ALUVIA**

**CONJUNTO MEZCLA. LAVAMANOS 4 AV102  
ALUVIA**

**CONJUNTO MEZCLA. LAVAMANOS 8 AV106  
ALUVIA**

**CONJUNTO MEZCLA. LAVAMANOS AV105 8  
ALUVIA**



**CONJUNTO MEZCLA. LAVAPLATOS AV506  
ALUVIA**



**DESAGUE AUTOMATICO 01-1933-04  
GRICOL**

**GRIVAL**

**DESAGUE AUTOMICO CROMADO 93100  
GRIVAL**



**DESAGUE LAVAMANOS 580314-581082  
INALG**



**DESAGUE PUSH CORTO CG121 NEGRO**



**DESAGUE PUSH EXTRA SIN REBOSE  
6M1-10033**

**GRIVAL**

**DESAGUE PUSH LARGO SIN REBOSE**  
01-3212-11



**DESAGUE PUSH MET CON REBOSE 93539**  
GRIVAL



**DESAGUE PUSH METALICO SIN REBOSE**  
93538



**DESAGUE PUSH PLAST SIN REB CORTO**  
3210-11



**DESAGUE PUSH PLASTICO CON REBOSE**  
93541

  
**GRICOL**

**DESAGUE PUSH SIN REBOSE 01-2900-11**  
GRICOL

**GRIVAL****DESAGUE PUSH SIN REBOSE CROMADO DM****DESAGUE SENCIL+SIFON BOTELLA 93154  
GRIVAL****PAVCO****DESAGUE SENCILLO 11087 PAVCO****GRIVAL****DESAGUE SENCILLO 93533-93112 GRIVAL**
  
**GRICOL**
**DESAGUE SENCILLO GRICOL 01-1930-04  
CON REBOSE****DESAGUE SENCILLO SIN REB. 01-1937-11**



**GRIVAL**

**DESAGUE SIFON ORINAL-LAVAM 93300  
GRIVAL**



**DESAGUE TIPO PUSH SIN REBOSE NEGRO**



**DESVIADOR TELEDUCHA PLAST CRO  
RB-1960-11**

**PAVCO**

**DUCHA BLANCO 2907879 PAVCO**



**DUCHA ELECT. GRAN DUCHA 220V  
BLANCA TC**



**DUCHA ELECT. SUPER DUCHA 3T 220V TC**

**GRIVAL**

**DUCHA ELECTRICA 110W MEGADU 73425  
GRIVAL**



**DUCHA ELECTRICA 110W SUPERPOWER 3T  
73430**



**DUCHA ELECTRICA ELEGANCE 220V  
BLANCA TC**



**DUCHA ELECTRICA SUPER DUCHA 4T 220V  
BLANCA**



**DUCHA MC GRETA PRO SSB MATE BLACK  
PM405**

**GRIVAL**

**DUCHA MONOCONTROL ALUVIA AV415  
GRIVAL**

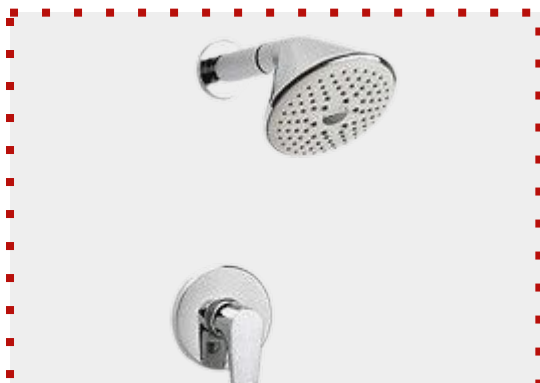

**DUCHA MONOCONTROL CASCADE PLUS  
CA4045**

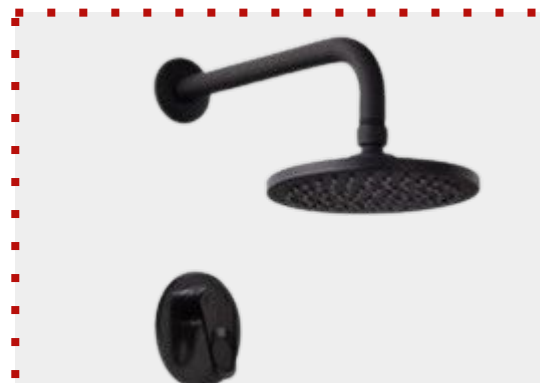

**DUCHA MONOCONTROL KORAL MATE  
BLACK KR408**



**DUCHA MONOCONTROL LIQUID NIQUEL  
LQ409**



**DUCHA MONOMANDO 01-2201-11 SIN REG  
GRIC**



**DUCHA MONOMANDO DESIN 20DN5313401  
STRETT**



**DUCHA OXACA 580425 INALG.**

**DUCHA SENCILLA LITE GM1-7025 TU CASA****GRICOL****DUCHA TELEF. 3 CHORROS TB-2000-11  
GRICOL****EXTRACTOR DE AIRE BAÑOS MCO  
ELEGANCE 100****GRIVAL****FILTRO AGUA 2 ETAP BAJO MESON 79743  
GRIVAL****FILTRO AGUA 2 ETAPA GRIFO MESON 79739****GRIVAL****FLOTADOR METALICO 1/2 GRIVAL 96706.**

**GRIVAL****FLOTADOR PLASTICO 1/2 GRIVAL 80640****GRIFERIA BIDET ASTOR CROMO  
DECORCERAMICA****GRIFERIA DS 80722T INSPIRACION****PAVCO****GRIFO ALT COCINA BLANCO/CRIS 2907870  
PAVCO****PAVCO****GRIFO ALTO COCINA BLANCO 2907872  
PAVCO****PAVCO****GRIFO ALTO LAVAMANOS BLANCO 2907874  
PAVCO**

**PAVCO**

**GRIFO BAJO LAVAMANOS BLANCO**  
2907875  
**PAVCO**



**GRIFO LAVADERO+PUNTA MANGUERA**  
**BLANCO**

**PAVCO**

**GRIFO PARED COCINA BLANCO 2908715**  
**PAVCO**



**INCRUSTACION INTERMATEX ESFERA**  
**JUEGO X 6**



**INCRUSTACION INTERMATEX PLUS JUEGO**  
**X 6**



**GRIFO ALTO LAVAMANOS BLANCO 2907874**  
**PAVCO**

**GRIVAL**



**INCRUSTACION PALERMO PL61000 X 6 P.  
GRIVAL**

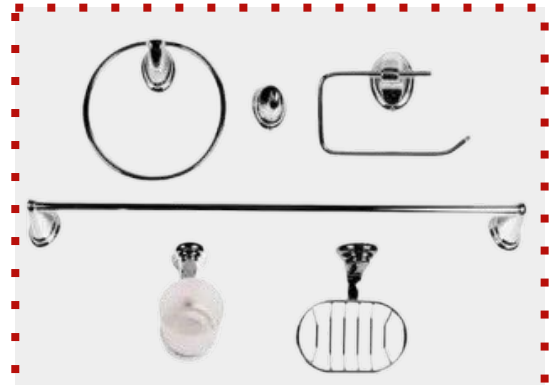

**INCRUSTACION TRAVEL JUEGO X 6  
SPLENDOR**

**GRIVAL**



**INCRUSTACION VALENCIA 54604 X 6 P.  
GRIVAL**

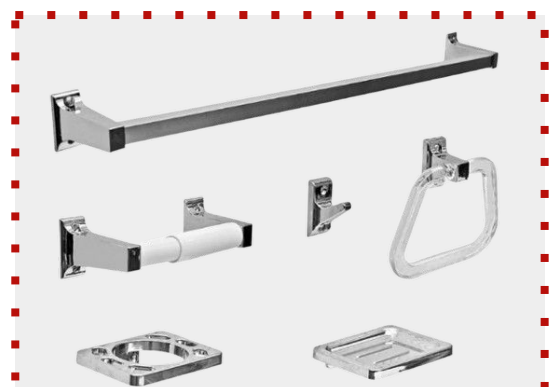

**INCRUSTACION X 6 P. 21LZ6000001  
STRETTO**



**INCRUSTACION XCARET JUEGO X 6 TU  
CASA**

**GRIVAL**



**JABONERA PALERMO PLATO PL6030  
GRIVAL**



**JABONERA URBAN DORADA  
DECORCERAMICA**



**JABONERA URBAN NEGRA  
DECORCERAMICA**

**GRIVAL**

**JABONERA VALENCIA 54635 GRIVAL**



**JARRA FILTRANTE CON CONTADOR**

**GRIVAL**

**KIT ACCESORIOS ALUVIA AV600 X 6 P.  
GRIVAL**



**KIT ACCESORIOS CASCADE CA606  
CROMADA**





**KIT ACCESORIOS GRETA PM119  
MATEBLACK**



**KIT ACCESORIOS KORAL KR600X6**



**KIT BIDE CON REGULA METALICA DOBLE  
93733**



**KIT DUCHA MARS TU CASA**



**KIT LAVAMANOS 4 FLORENCIA  
20FR45030L**



**KIT LLAVE LAVAMANOS SENC  
20MR2103003 STR**



**KIT SANITARIO COMPLETO CLASICO**  
2910948



**KIT TOALLERO BARRA + PORTA PAPEL**  
TOILET



**KIT VALVULA PEDAL DE LAVAMANOS 54719**  
GRICOL



**LLAVE 1/2 PASO CROM. 95720 GRIVAL**



**LLAVE ABASTO CROM. 01-9911-11GRICOL**



**LLAVE AUTOMATICA SENSOR PLA 003 ANT**

**GRIVAL****LLAVE DE JARDIN 79727/79729 GRIVAL****GRIVAL****LLAVE DE JARDIN 79728 GRIVAL****GRICOL****LLAVE DE JARDIN LIVIANA 01-9983-13  
GRICOL****LLAVE DE JARDIN PLASTICA BLANCA  
1901-15****LLAVE DE JARDIN RANGER****PAVCO****LLAVE DE PASO DUCHA BLANCO 2907878  
PAVCO**



**LLAVE DUCHA CORNY GM0-1009 TU  
CASSAL**



**LLAVE DUCHA MONOCONTROL URBAN  
DORADO**



**LLAVE DUCHA MONOCONTROL URBAN  
NEGRO**



**LLAVE DUCHA MONOCONTROL URBAN  
ROJO**



**LLAVE JARDIN CON EXT 38043-97911  
GRIVAL**



**LLAVE LAVADORA 79736 GRIVAL**



**LLAVE LAVAMAN BAJA VIVALDI  
01-2103-11SD**



**LLAVE LAVAMANOS MC ALTA URBAN ORO  
ROSA**



**LLAVE LAVAMANOS 01-0900-11 GRICOL**



**LLAVE LAVAMANOS ALT VIVALDI  
01-2106-11SD**



**LLAVE LAVAMANOS ALTA MC CASCADE  
CA1100**



**LLAVE LAVAMANOS BALTA 41123 GRIVAL**

**GRIVAL**

**LLAVE LAVAMANOS CASCADE ALTO  
CA1045 GRIVAL**



**LLAVE LAVAMANOS CON SENSOR DAFNE  
TU CASA**



**LLAVE LAVAMANOS ECO  
STRETTO-MOSSINIL**



**LLAVE LAVAMANOS INDIV PCA ALUVIA  
AV4110**



**LLAVE LAVAMANOS LIQUID ALTA  
CROMADA**

**GRICOL**

**LLAVE LAVAMANOS MC ALTA 2606-11  
GRICOL**



**LLAVE LAVAMANOS MC ALTA CUSCO  
PM1305**



**LLAVE LAVAMANOS MC ALTA DENVER  
NEGRO**

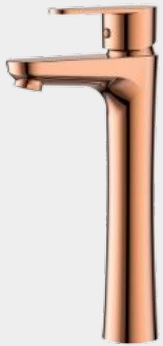

**LLAVE LAVAMANOS MC ALTA DENVER-BR  
ORO**



**LLAVE LAVAMANOS MC ALTA HOME-CP  
ACERO**



**LLAVE LAVAMANOS MC ALTA MONET  
MO1015**



**LLAVE LAVAMANOS MC ALTA URBAN  
DORADA**



**LLAVE LAVAMANOS MC ALTA URBAN  
NEGRA**



**LLAVE LAVAMANOS MC ALTA VOGA  
01-3706-11**



**LLAVE LAVAMANOS MC BAJA 1-2603-11  
GRICOL**



**LLAVE LAVAMANOS MC BAJA CHICAGO  
NEGRO**



**LLAVE LAVAMANOS MC BAJA  
SANTORINI-BR**



**LLAVE LAVAMANOS MC BAJA URBAN-BR  
CROMO**



**LLAVE LAVAMANOS MC BAJA URBAN-CP****LLAVE LAVAMANOS MC BAJA VOGA  
01-3703-11****LLAVE LAVAMANOS MC CASCADE MEDIA  
CA1035****LLAVE LAVAMANOS MC FIORENZO NEGRO  
MATE****LLAVE LAVAMANOS MC GRETA ALTA  
PM1165****LLAVE LAVAMANOS MC GRETA ALTO  
PM1020**

**LLAVE LAVAMANOS MC INNA ALTA NN1030****LLAVE LAVAMANOS MC KORAL ALTA  
KR1230****LLAVE LAVAMANOS MC KORAL MEDIA  
KR117/22****LLAVE LAVAMANOS MC MEDIA CUSCO  
PM1295****LLAVE LAVAMANOS MC OBI BAJO OB1015  
GRIVAL****GRIVAL****LLAVE LAVAMANOS MC PALMA-GRET MED  
PM1010**



**LLAVE LAVAMANOS MC THAMES ALTO  
TH1025**



**LLAVE LAVAMANOS MC THAMES BAJO  
TH1015**



**LLAVE LAVAMANOS MEDIA MONOCONT  
CASCADE**



**LLAVE LAVAMANOS MESA TIPO PUSH 94712**



  
**GRICOL**

**LLAVE LAVAMANOS METALICA 01-0815-21  
GRICOL**



**LLAVE LAVAMANOS MONOC ALTA  
URBAN-CROMADA**

**GRIVAL**

**LLAVE LAVAMANOS MONOC ALUVIA  
AV4130 GRIVAL**



**LLAVE LAVAMANOS MONOCONT KORAL  
KR110551**



**LLAVE LAVAMANOS SENCILLA EX-1400-11  
GRICOL**



**LLAVE LAVAMANOS TEDESCA 01-1800-11  
GRICOL**

**GRIVAL**

**LLAVE LAVAMANOS VERA ALTA VA1018  
GRIVAL**



**LLAVE LAVAP. SENC. 20MC0403001  
MOSSINI**



**LLAVE LAVAPLATOS CAPRI 580222  
INALGRIFOS**



**LLAVE LAVAPLATOS MC ATLANTA  
20AT5603000**



**LLAVE LAVAPLATOS MC ALTA LOFT  
BLANCO**



**LLAVE LAVAPLATOS MC FIORENZO NEGRO  
MATE**



**LLAVE LAVAPLATOS MC HORIZ  
20AT5403000**



**LLAVE LAVAPLATOS MC HORIZ  
20AT5403000**



**LLAVE LAVAPLATOS MONOC ALUVIA  
AV4140**



**LLAVE LAVAPLATOS MONOC URBAN  
NEGRO**



**LLAVE LAVAPLATOS MONOCONT 01-2115-11**



**LLAVE LAVAPLATOS MONOCONT  
01-2209-11**



**LLAVE LAVAPLATOS MONOCONT. LIQUID  
LQ500**



**LLAVE LAVAPLATOS MONOCONTROL  
KORAL MATEB**



**LLAVE LAVAPLATOS MONOCONTROL VERA  
BASIC**



**LLAVE LAVAPLATOS MOVIL 01-0837-11  
CALIMA**



**LLAVE LAVAPLATOS MOVIL MESA  
01-1850-11**



**LLAVE LAVAPLATOS PARED 41509 BALTA  
GRIVAL**



**LLAVE LAVAPLATOS PARED C EX-0944-11  
GRICOL**



**LLAVE LAVAPLATOS SENC OASIS GM1-4025**



**LLAVE LAVAPLATOS SENC SOLID CROMO  
SD5000**



**LLAVE LAVAPLATOS SENCILLA 45507  
NOGAL**



**LLAVE LAVAPLATOS SENCIL MESA AV504  
ALUVI**



**LLAVE LAVAPLATOS SENCILLA HOME  
ACERO CP**



**LLAVE LAVAPLATOS SENCILLA MESA AV503**



**LLAVE MOVIL MESA 01-2837-11 GRICOL**





**LLAVE MOVIL MESA LAVAPL TOSCANA  
1450-11**

**GRIVAL**

**LLAVE PASO BOLA 1 79702 GRIVAL**

**GRIVAL**

**LLAVE PASO BOLA 1.1/2 79704 GRIVAL**

**GRIVAL**

**LLAVE PASO BOLA 1.1/4 79703 GRIVAL**

**GRICOL**

**LLAVE PASO BOLA 1/2 01-0105-30 GRICOL**

**GRIVAL**

**LLAVE PASO BOLA 1/2 79700 GRIVAL**

**GRIVAL**



LLAVE PASO BOLA 1/2 MARIP. 79706  
GRIVAL

**GRIVAL**



LLAVE PASO BOLA 3/4 79701 GRIVAL



LLAVE PASO DTO. 1.1/2 T.L.



LLAVE PASO DTO. 1.1/2 T.P.



LLAVE PASO DTO. 1/2 T.P.



LLAVE PASO DTO. 3/4 T.P. NM

**GRIVAL**

**LLAVE TERMINAL CON MANIJA ANIMALITO  
ANT**



**LLAVE TERMINAL DOBLE SALIDA 97906  
GRIVAL**



**MANGUERA ACOPLA CALENTADOR 40 CMS  
02394**



**MANIJA PIANA RB-1523-11 GRICOL**



**MEDIDOR 1 CALIBRADO CHORRO  
MULTIPLE.**



**MEDIDOR 1/2 VELOCIDAD R160  
CALIBRADO**



**MEZCLADOR DUCHA 01-0820-11 CALIMA  
CROM**



**MEZCLADOR DUCHA 01-0935-11 HELVETIA  
CROM**

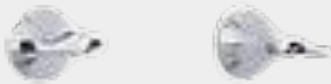



**GRICOL**

**MEZCLADOR DUCHA 01-1822-11 TEDESCA  
GRICOL**

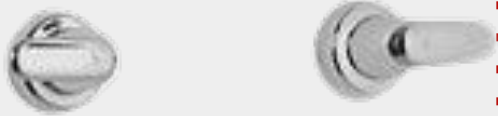

**GRICOL**

**MEZCLADOR DUCHA 8 01-1535-11 GRICOL**



**MEZCLADOR DUCHA 8 ALUVIA AV401  
PALANCA**



**MEZCLADOR DUCHA 8 ALUVIA AV404  
CRUCETA**

**GRICOL**

**MEZCLADOR DUCHA 8 BALTA PCA  
BL401/41423**

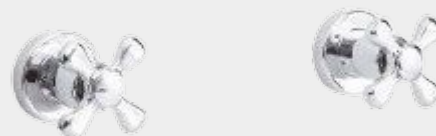

**MEZCLADOR DUCHA 8 C1-0820-115R  
GRICOL**



**MEZCLADOR DUCHA 8 NOGAL 41429 SIN  
REGAD**



**MEZCLADOR DUCHA 8" ATRATO CRUCETA  
3 FUNC**



**MEZCLADOR DUCHA BALTA 41412  
PALANCA GRIV**



**MEZCLADOR DUCHA CON DTE Y  
REGADERA 30 CM**

**GRIVAL**

**MEZCLADOR DUCHA DRAA SSB DR4015551  
GRIVAL**

**GRICOL**

**MEZCLADOR DUCHA MONOC AREZZO  
NEGRO MATE**

**GRIVAL**

**MEZCLADOR DUCHA MONZA  
20MX5013000 STRETT**



**MEZCLADOR DUCHA VAAL SSB VV400  
GRIVAL**

**GRICOL**

**MEZCLADOR LAVAMANOS 4 01-0811-11  
GRICOL**



**MEZCLADOR LAVAMANOS 4 580933 INALG**

**GRIVAL**

**MEZCLADOR LAVAMANOS 4 NOGAL 54114  
GRIVAL**

**GRICOL**

**MEZCLADOR LAVAMANOS 4" EX-2802-11  
GRICOL**



**MEZCLADOR LAVAMANOS 8 23100  
CENTURY**



**MEZCLADOR LAVAMANOS 8 41119 BALTA**

**GRIVAL**

**MEZCLADOR LAVAMANOS 8 CEDRO CE1175  
GRIVAL**

**GRIVAL**

**MEZCLADOR LAVAMANOS 8 CEDRO CE1175  
GRIVAL**



**MEZCLADOR LAVAPLATOS 01-0801-11  
CALIMA**



**MEZCLADOR LAVAPLATOS 41502 BALTA  
CTA**



**MEZCLADOR LAVAPLATOS CASCADE 8 "  
CA5015**



**MEZCLADOR LAVAPLATOS VELERY  
GM1-4008**

**GRIVAL**

**PERCHA SIMPLE ATTICA 54610 GRIVAL**



**PERCHA SIMPLE PALERMO REF. PL602001**

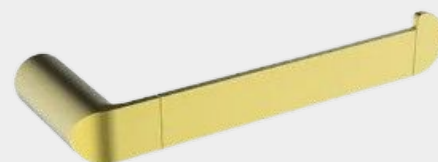

**GRIVAL****PERCHA VALENCIA 54632 GRIVAL****PERCHERO HOME ACERO  
DECORCERAMICA****PERCHERO URBAN DORADO  
DECORCERAMICA****PERCHERO URBAN NEGRO  
DECORCERAMICA****POLIFLEX LAVAMANOS - LAVAP  
01-1920-00****POLIFLEX LAVAMANOS LARGO 38012**

**GRIVAL****POLIFLEX LAVAMANOS LARGO 38012****PORTA ROLLO ATTICA 54612 GRIVAL****PORTAPAPEL COCINA BLANCO 387  
REJIPLAS****PORTARROLLO URBAN DORADO  
DECORCERAMICA****PORTARROLLO URBAN NEGRO  
DECORCERAMICA****REGADERA CUADRADA CON BRAZO SLIM 8  
NEGRO**

**GRICOL**
**REGADERA ISEO 21X21 BL 8730-11 GRICOL****GRIVAL****REGADERA NOGAL CON BRAZO 43450  
GRIVAL****REGADERA PALMA PM401 GRIVAL****REGADERA REDONDA URBAN 22CM  
NEGRO MATE****REGADERA REDONDA URBAN 25 CM  
DORADO****REGADERA REDONDA URBAN 25 CM ROJO  
ORO**

  
**GRICOL**
**REGADERA TORINO BL-3730-11 GRICOL**

  
**GRICOL**
**REGADERA VICO BL-8530-11 GRICOL**

  
**GRICOL**
**REGISTRO DUCHA 01-0823-11 GRICOL****GRIVAL****REGISTRO DUCHA ALUVIA PALANCA  
AV407  
GRIVAL**

  
**GRICOL**
**REGISTRO DUCHA GRICOL 01-1533-11****REGISTRO DUCHA MC SION 01-2601-11SR**

**REGISTRO DUCHA MC VIVALDI 01-2101-11SR****GRICOL****REGISTRO DUCHA MONO 20NS5703400  
STRETTO****GRIVAL****REGISTRO DUCHA PASO DE BOLA BO40100  
GRIVAL****REGISTRO DUCHA SLIM PALANCA 101746  
GERFO****REGISTRO MONOCONTROL DUCHA ANT****REGULACION PLAST 1/2" LAVAM-SANIT  
95790**



**REGULACION PLAST. 1/2 DOBLE SALIDA  
96762**



**REJILLA ACERO RECT PERFOR 80X11 93785**

**GRIVAL**

**REJILLA PISO ACERO INOXID. 93721 GRIVAL**



**REJILLA PISO CUADRADA OPTIMA 10X10 TC**

**GRIVAL**

**REJILLA PISO METALICA CLASICA 93722  
GRIVAL**

**GRIVAL**

**REJILLA PISO REDONDA 3 93707 GRIVAL**

**REJILLA PISO VANGUAR 10X10 CM 93720**
**GRIVAL**
**REJILLA RECT. PISO ACERO 80CM 93785  
GRIVAL**

**REPUESTO TORRE PLAST. IZQ. RB-0201-02**
**GRICOL**
**REPUESTO TORRE PLAST. RB-0201-15  
GRICOL**
**PAVCO**
**REPUESTO UNIV GRIF COCINA/BAÑO  
PAVCO**
**PAVCO**
**RESISTENCIA DUCHA ADVANCED 127V  
PAVCO**

**PAVCO****RESISTENCIA DUCHA MAXI 4T 127V PAVCO****SET DUCHA MC HOME-CP ACERO  
DECORCERAMICA****GRIVAL****SIFON BOTELLA 2 TB-1942-11S CROMADO****SIFON BOTELLA FLEXIBLE DOBLE 93759  
GRIVAL****PAVCO****SIFON BOTELLA LAVAMANOS 11615 1 1/2  
PAVCO****GRICOL****SIFON EN P EXPAND. 01-2907-15 GRICOL**



**GRIVAL****SIFON FLEXIBLE CROMADO 93549 GRIVAL**

**GRICOL**
**SIFON LAVAPLATOS EN P 01-1941-15 GRICOL****PAVCO****SIFON LAVAPLATOS EN P 01-9997-11 CROMADO****SIFON LAVAPLATOS EN P CON ADAP PAVCO****GRIVAL****SIFON METALICO CLASICO 71951 GRIVAL****GRIVAL****SIFON REPOSICION EN P 71960 GRIVAL**

**GRIVAL**

**SUBCONJUNTO MC LAVAMANOS KORAL  
ALT KO100**



**TELEDUCHA ALUVIA AV409 GRIVAL**

**GRIVAL**

**TELEDUCHA KORAL KR-4050001 GRIVAL**

**GRIVAL**

**TELEDUCHA NOGAL 43447 GRIVAL**

**GRIVAL**

**TOALLERO ARGOLLA ATTICA 54608  
GRIVAL**



**TOALLERO ARGOLLA PALERMO PL60500**

**GRIVAL**

**TOALLERO ARGOLLA VENECIA VC604  
GRIVAL**



**TOALLERO BARRA 23.1CM URBAN NEGRO**



**TOALLERO BARRA 23.1CM URBAN-CP  
DORADO**



**TOALLERO BARRA 60CM URBAN DORADO  
DECORCE**



**TOALLERO BARRA 60CM URBAN NEGRO  
DECORCET**

**GRIVAL**

**TOALLERO BARRA ALUVIA AV607 GRIVAL**

**GRIVAL****TOALLERO BARRA VALENCIA 54631 GRIVAL****TORRE DUCHA TAMESIS CROMADA TU CASSA****TORRE DUCHA VOLGA CROMADA TU CASSA****VAL CHEQUE HIDRO 1/2" S. NITRILO****VAL CHEQUE HIDRO 3/4" S. NITRILO****VALVULA 3 EN 1 BOLA + CHEQUE + FILTRO**



**VALVULA BOLA BUGATTI BRONCE  
CROMADO ROSC**

**GRIVAL**

**VALVULA COMPUERTA 1 79711/70765  
GRIVAL**

**GRIVAL**

**VALVULA COMPUERTA 1/2 79709/70763  
GRIVAL**

**GRIVAL**

**VALVULA COMPUERTA 3/4 79710 GRIVAL**



**VALVULA DE BOLA ANTIFRAUDE 1/2 71743**



**VALVULA DE LLENADO EXTENDIBLE  
2910956**



**VALVULA DE PIE EN LATON 1 1/2  
CANASTILLA**



**VALVULA DE REGULACION 1/2 96736-96735**



**VALVULA DESCARGA DUAL AJUST 2" 79914**



**VALVULA DESCARGA DUAL AJUST 3 BAJA  
79929**



**VALVULA ENTRADA ATLAS 80633**



**VALVULA FLOTADORA COMPLET BOLA  
COBRE 1/2**

**VALVULA FLOTADORA EN LATON H&F 1/2"****VALVULA LLENADO UNIVERSAL PLUS  
022850****GRIVAL****CONJ MEZCLA. LAVAPLATOS 45514 NOGAL  
GRIVAL**

**GRICOL**
**CONJUNTO DUCHA 01-0934-11 GRICOL****ACCESORIO KISS ORO ROSA TU CASSA****ACCESORIO MILANO NEGRO TU CASSA**

**DESAGUE PUSH SIN REB KISS ORO ROSA TC****DUCHA DALIA BLACK TU CASSA****DUCHA ZAMBIA BLACK TU CASSA****CONJUNTO DUCHA 01-0934-11 GRICOL****GRIFERIA KENAY BLACK 2 TU CASSA****GRIFERIA MIXER CHROME TU CASSA**

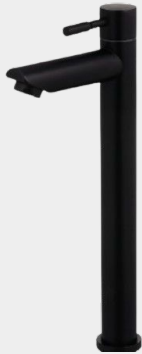
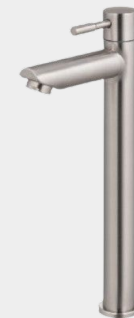

**GRIFERIA NAOS BLACK TU CASSA****GRIFERIA STARK 2 TU CASSA****DESAGUE PUSH SIN REBOSE NEGRO DM****DESAGUE PUSH SIN REBOSE ORO ROSA DM****REJILLA STANDARD NEGRA 10X10 DM****GRIFERIA NAOS ALTA SATIN TU CASSA**

# POLVOS

- Pegantes 259
- Boquillas 263
- Concolor 264
- Yeso 265





**PEGAMASTER BLANCO X 10 KG / 25 KG**



**PEGAMASTER GRIS X 10 KG / 25 KG**



**PEGAMASTER PARCELA PISCINA  
(BLANCO - GRIS) X 25 KG**



**PEGAMASTER PORCELÁNICO  
(BLANCO - GRIS) X 25 KG**



**PEGANTE CERAMICO GLADIADOR  
MAX 25KG**

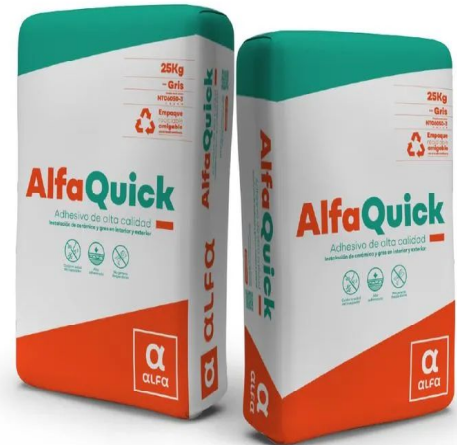

**PEGANTE CERAMICO ALFAQUIK  
GRIS X 25KG**

**PEGACOR**

PEGACOR BLANCO

PEGACOR GRIS

PEGACOR PORCELANICO GRIS



## PEGAPLUX

PEGAPLUX CERAMICO EXTERIOR GRIS X 25 KG

PEGAPLUX CERAMICO GRIS X 25 KG

PEGAPLUX PISCINAS GRIS X 25 KG

PEGAPLUX PORCELAN. INTERIOR GRIS X 25 KG



**PEGATEK CERAMICO GRIS X 25 KG**



**COMPLEMENTOS** □

**BOQUILLA****BINDA BOQUILLA**

BINDA BOQUILLA ACRILICA X 10 KG. BLANCO

BINDA BOQUILLA ACRILICA X 2 KG. BEIGE

BINDA BOQUILLA ACRILICA X 2 KG. BLANCO

BINDA BOQUILLA X 10 KG. BEIGE

BINDA BOQUILLA X 10 KG. BLANCO

BINDA BOQUILLA X 2 KG. BLANCO

**BOQUILLA SIKACERAM**

BOQUILLA SIKACERAM-630 BLANCA X 10 KG.

BOQUILLA SIKACERAM-630 BLANCO X 2 KG.

BOQUILLA SIKACERAM-630 COLOR BEIGE X2 KG

BOQUILLA PLUS SIKACERAM-650 BLANCO X10KG



**BOQUILLA**

BOQUILLA OCRE CTE X 2 KG.

BOQUILLA ROJA CTE X 2 KG.

BOQUILLA TABACO CTE X 2 KG.

BOQUILLA TABACO EXTRAFINA X 2 KG

BOQUILLA VERDE EXTRAFINA X 2 KG

BOQUILLA OCRE EXTRAFINA X 2 KG

BOQUILLA BLANCA CTE X 2 KG

BOQUILLA BLANCA EXTRAFINA X 2 KG

BOQUILLA GRIS CTE X 2 KG.





BOQUILLA GRIS EXTRAFINA X 2 KG





BOQUILLA MARFIL CTE X 2 KG.

BOQUILLA MARFIL EXTRAFINA X 2 KG

BOQUILLA NEGRA CTE X 2 KG.

BOQUILLA NEGRA EXTRAFINA X 2 KG



**BLANCO  
ANTIGUO**

**GRIS  
CLARO**

**BLANCO  
HUESO**

**NEGRO**

**AMARILLO**

**SUPER  
BLANCO**

**ROJO  
TOSCANA**

**BEIGE**

**TABACO**

**VERDE**

**CONCOLOR**

CONCOLOR BEIGE X 2 KG

CONCOLOR BEIGE X 5 KG

CONCOLOR BLANCO ANTIGUO X 2 KG

CONCOLOR BLANCO ANTIGUO X 5 KG

CONCOLOR BLANCO HUESO 2 EN 1 X 8 KG

CONCOLOR BLANCO HUESO X 2 KG

CONCOLOR BLANCO HUESO X 5 KG

CONCOLOR CACAO X 2 KG

CONCOLOR CHOCOLATE X 2 KG

CONCOLOR CHOCOLATE X 5 KG

CONCOLOR GRIS CEMENTO X 2 KG

CONCOLOR GRIS CLARO X 2 KG

CONCOLOR GRIS CLARO X 5 KG

CONCOLOR NEGRO X 2 KG

CONCOLOR NEGRO X 5 KG

CONCOLOR ROJO TOSCANA X 2 KG

CONCOLOR SUPER BLANCO X 2 KG

CONCOLOR SUPER BLANCO X 5 KG

CONCOLOR TABACO X 2 KG

CONCOLOR TORTORA X 2 KG





**YESO**

BULTO CAL HIDRAT MAESTRO X 10 KL. FARAON

BULTO CAOLIN BLANCO OIBA

BULTO YESO DAVINCI X 25 KG.

BULTO YESO ESCAYOLA FARAON

BULTO YESO ESCAYOLA MODELOX25 KG. CORONA

BULTO YESO MAXIYESO SUPERESCAAYOLA X25 KG

CAOLIN BLANCO X 25 KG PROCALCO

BULTO YESO ESCAYOLA FARAON

BULTO YESO DAVINCI X 25 KG.

BULTO YESO MAXIYESO SUPERESCAAYOLA X25 KG



# MATERIAL DE ARRASTRE

- Granito (Bultos) 267
- Gravilla y Triturado 268
- Ladrillos de Piedra 269
- Arena 270



**Granito (Bultos)****BULTO GRANITO BLANCO N. 2****BULTO GRANITO BLANCO N. 4****BULTO GRANITO COMBINADO N. 2****BULTO GRANITO GRIS PERLA N. 2****BULTO GRANITO NEGRO N. 2**

## Gravilla y Triturado

### BULTO GRAVILLA LAVADA



### TRITURADO MT.



**Ladrillos de Piedra****LADRILLO PIEDRA AMARILLO****LADRILLO PIEDRA NEGRO****LADRILLO PIEDRA PEQUEÑA****LADRILLO PIEDRA AMARILLO ENSACAD****LADRILLO PIEDRA PEQUEÑA ENSACADA****LADRILLO PIEDRA NEGRO ENSACADA**

**ARENA****ARENA AMARILLA (GRUESA DE PESCADERO) MT.****ARENA NEGRA (DE RIO PARA PAÑETES) MT.**

## ACC. ELECTRICOS

- Alambres 272
- Espiral Coraza 273
- Interruptores 279
- Plafon Tacos Coaxial 276
- Pulsadores Zumbadores 278



**ALAMBRE DUPLEX**

ALAMBRE DUPLEX NO. 10 MT.

ALAMBRE DUPLEX NO. 12 MT.

ALAMBRE DUPLEX NO. 14 MT.

ALAMBRE DUPLEX NO. 18 MT.

ALAMBRE DUPLEX NO. 22 MT.

**ALAMBRE ELECTRICO**

ALAMBRE ELECT # 10 MT.

ALAMBRE ELECT # 12 MT.

ALAMBRE ELECT # 14 MT.

ALAMBRE ELECT # 8 MT.

**ALAMBRE****CABLE**

CABLE NO. 14 7 HILOS MT.



## ESPIRAL - CORAZA

### BOLSA ESPIRAL

BOLSA ESPIRAL 1/2 BCO FB-12X10 MT. ADLER

BOLSA ESPIRAL 1/2 NEGRO FN-12X10 MT. ADL

BOLSA ESPIRAL 3/8 BCO FB-09X10 MT. ADLER

BOLSA ESPIRAL 3/8 NEGRO FN-09X10 MT. ADL



### CORAZA

CORAZA BLANCA 3/4 CERRA CCPPB19 ADLER MT

CORAZA VERDE 1/2 PVC CCPVC-17 ADLER MT.

CORAZA VERDE 3/4 PVC CCPVC-22 ADLER MT.



### PANEL LED PLANO 26W 30X30 LUZ BLANCA

## INTERRUPTOR DOBLE

INTERRUPTOR DOBLE

INTERRUPTOR DOBLE NOVA BLANCO CILES

INTERRUPTOR DOBLE SPAZIO BLANCO CILES

INTERRUPTOR DOBLE ULTRA PLUS BLANCO CILE



## INTERRUPTOR SENCILLO

INTERRUPTOR SENCILLO

INTERRUPTOR SENCILLO CONM NOVA BLANCO CI

INTERRUPTOR SENCILLO CONM SPAZIO BLANCO

INTERRUPTOR SENCILLO CONM ULTRA PLUS

INTERRUPTOR SENCILLO NOVA BLANCO CILES

INTERRUPTOR SENCILLO SPAZIO BLANCO CILES

INTERRUPTOR SENCILLO ULTRA PLUS BLANCO



# INTERRUPTORES

## INTERRUPTOR TRIPLE

INTERRUPTOR TRIPLE CONM NOVA BLANCO CILE

INTERRUPTOR TRIPLE NOVA BLANCO CILES



## INTERRUPTOR Y TOMA CORRIENTE

INTERRUPTOR Y TOMA NOVA BLANCO CILES

INTERRUPTOR Y TOMA POLO A TIERRA SPAZIO



## PILA VARTA GRANDE



## PLACA MÁS SOPORTE CIEGA NOVA BLANCA

## PLAFÓN

PLAFON 4.1/2 E-27 CILES

PLAFON PLASTICO



## SALIDA COAXIAL

SALIDA COAXIAL SENCILLA NOVA BLANCO CILE

SALIDA COAXIAL SENCILLA SPAZIO BLANCO

SALIDA COAXIAL SENCILLA ULTRA PLUS BLANC



## TACO

TACO 50 AMPERIOS

TACO ENCHUFABLE 20 AMP CILES

TACO ENCHUFABLE 30 AMP CILES

TACO ENCHUFABLE 40 AMP CILES



## TOMA DOBLE

TOMA DOBLE C.P.T. LEVINTON

TOMA DOBLE GFCI NOVA BLANCO CILES

TOMA DOBLE INT NOVA BLANCO CILES

TOMA DOBLE INTEGRAL C.P.T. SPAZIO BLANCO

TOMA DOBLE INTEGRAL C.P.T. ULTRA PLUS

TOMA DOBLE POL.TIER

TOMA GFCI



## TOMA TELEFÓNICA

TOMA TELEF AMERIC SENCILLA NOVA BLANCO

TOMA TELEF AMERIC SENCILLA SPAZIO BLANCO

TOMA TELEF AMERIC SENCILLA ULTRA PLUS

TOMA TELEFONO AMERICANO LUM



## ZUMBADOR

ZUMBADOR NOVA BLANCO CILES

ZUMBADOR SPAZIO BLANCO CILES

ZUMBADOR ULTRA PLUS BLANCO CILES



## PULSADOR

PULSADOR TIMBRE SENCILLO NOVA BLANCO CIL

PULSADOR TIMBRE SENCILLO SPAZIO BLANCO

PULSADOR TIMBRE SENCILLO ULTRA PLUS BCO



## INTERRUPTOR SOBRE MURO SENCILLO

**ROLLO CINTA AISLANTE COBRA****ROLLO CONDUGAS 1/2 BLANCO  
X 50 MT. PAVCO**

## ACC. PUERTAS

- Candados 281
- Cerraduras 284
- Cerrojos 22 290
- Ojo Mágico - Topes 22 293

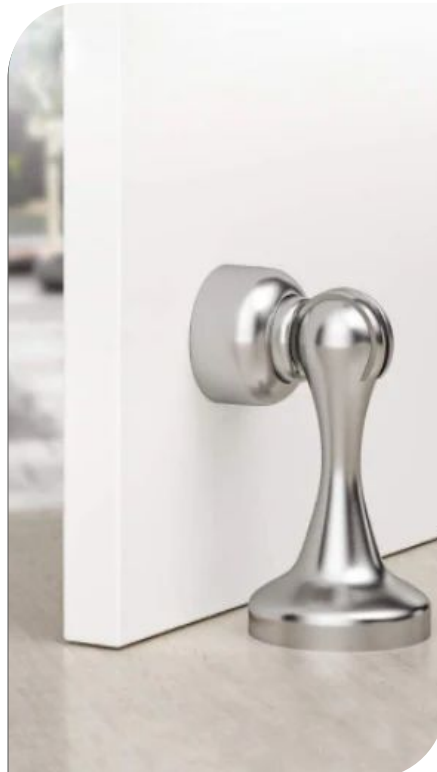



**CANDADO YALE**

CANDADO ALEMAN 800-40MM YALE

CANDADO ALEMAN 800-50MM YALE

CANDADO ALEMAN 800-70MM YALE

**CANDADO BLISTER ANTICIZALLA**

CANDADO BLISTER ANTICIZALLA N. 50

CANDADO BLISTER ANTICIZALLA N. 60

CANDADO BLISTER ANTICIZALLA N. 75

**CANDADO CORRIENTE**

CANDADO CORRIENTE # 50

CANDADO CORRIENTE 25MM FH25-B

CANDADO CORRIENTE 63MM FH63-B



**CANDADO DE HIERRO PHILLIPS**

CANDADO HIERRO 25 PHILLIPS

CANDADO HIERRO 32 PHILLIPS

CANDADO HIERRO 38 PHILLIPS

CANDADO HIERRO 45 PHILLIPS

CANDADO HIERRO 50 PHILLIPS

CANDADO HIERRO 63 PHILLIPS

**CANDADO DE HIERRO PHILLIPS**

CANDADO INTEMPERIE 51MM NEGRO YALE

CANDADO INTEMPERIE 61MM NEGRO YALE

CANDADO INTEMPERIE 71MM NEGRO YALE

**CANDADO PROF. 25 MM 8140  
CONSTRURAMA**

**CANDADO TIPO ITALIANO**

CANDADO TIPO ITALIANO 110-30MM YALE

CANDADO TIPO ITALIANO 110-40MM YALE

CANDADO TIPO ITALIANO 110-50MM YALE

CANDADO TIPO ITALIANO 110-60MM YALE

CANDADO TIPO ITALIANO 110-70MM YALE

**CERR SCHLAGE A40S ACCENT  
DER. CROM. MATE**

**CERR SCHLAGE A50WS BELL  
WOOD GOLD ALCOBA**

**CERRAD SCHLAGE A40S JUPITER  
ANTIQUE BAÑO**

**CERRAD YALE 2250 ECONOM  
PHILLIPS DERECHA**



**CERRAD YALE 6377 POMO MET  
PRINCIPAL CARO**



**CERRAD YALE 6476 MANIJA  
PRINCIPAL AUSTIN**



**CERRAD. INAFER C-1000 ANTIQUE**



**CERRAD YALE 2250 ECONOM  
PHILLIPS DERECHA**



**CERRAD. SCHLAGE A40S  
GEORGIA PLATINUM**



**CERRAD. SCHLAGE A40S GOLD BAÑO**



**CERRAD. SCHLAGE A40S JUPITER  
CROM MATE**



**CERRAD. SCHLAGE A50PD  
ORBIT ANTIQ.OFICIN**



**CERRAD. SCHLAGE A50WS ACCENT  
DER. CROM.**



**CERRAD. SCHLAGE A50WS JUPITER  
CROM MATE**



**CERRAD. SCHLAGE HC-380  
ORBIT ANTIQUE**



**CERRAD. SCHLAGE HE-380 ELEGANCE**



**CERRAD. SIENA NEGRA PRINCIPAL  
46297 VERA**



**CERRAD. SCHLAGE A50PD  
ORBIT ANTIQ.OFICIN**

**YALE 105-50 IZQ - DER**

CERRAD. YALE 105-50 2 BULONES SOBRE DER

CERRAD. YALE 105-50 2 BULONES SOBRE IZQ



**YALE 107-70 IZQ - DER**

CERRAD. YALE 107-70 SOBRE DERECHA

CERRAD. YALE 107-70 SOBRE IZQUIERDA





**CERRAD. YALE 6376 POMO MET  
ALCOBA CAROLI**



**CERRAD. YALE 6466 MANIJA BAÑO  
AUSTIN NEG**

**YALE 396-3022 IZQ - DER - NM**

CERRAD. YALE 396-3022 SOBRE IZQUIERDA

CERRAD. YALE 396-3025 SOBRE DERECHA

CERRAD. YALE 396-3026 SOBRE IZQUIERDA NM



**YALE 2250 IZQ**

CERRAD. YALE 2250 ECONOM PHILLIPS IZQ.





**CERRAD. YALE 6467 MANI ALCO  
AUSTIN NEGRO**



**CERRAD. YALE 6477 MANIJA  
PRINCIP ATLANTA**



**CERRAD. YALE 6478 MANIJA  
BAÑO AUSTIN**



**CERRAD. YALE 6479 MANIJA  
BAÑO ATLANTA**



**CERRAD. YALE 6480 MANIJA  
ALCOBA ATLANTA**



**CERRAD. YALE 6481 MANIJA  
ALCOBA AUSTIN**





**CERRAD. YALE 650 ECONOM  
PHILLIPS DERECHA / IZQUIERDA**



**CERRAD. YALE 8797 ELECTRICA  
IZQUIERDA**

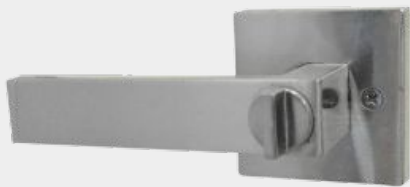

**CERRAD. YALE 9059 MANIJA  
PRINCIPAL BARI**



**CERRAD. YALE 984**



**CERRAD. YALE BAÑO ALUMINIO NO MIN**



**CERROJO SCHLAGE B262PX**

**CERROJO SCHLAGE B360 CROM. MATE**

**CERROJO SCHLAGE B362 CROMO. MATE**

**CERROJO YALE KENT NEGRO  
LLAVE LLAVE**

**CERROJO YALE KENT NEGRO  
LLAVE MARIPOSA**

**CERROJO YALE NEGRO LLAVE LLAVE**

**CERROJO YALE NEGRO LLAVE  
MARIPOSA**



**CERRAD GATO 271 ALCOBA  
POMO MADERA**



**CERRAD GATO 276 BAÑO  
POMO NEGRO**



**CERRAD DURALOCK 360 CUAD  
PPAL NEGRA**



**CERRAD DURALOCK 361 CUAD  
ALCOBA NEGRA**



**CERRAD DURALOCK 366 CUAD  
BAÑO NEGRA**



**CERRAD GATO 216 BAÑO MANIJA  
NEGRA**

**CHAPA GAVETA****CHAPETA 4 HILOS NO MIN****MADERA SEGURIDAD DORADO****MADERA SEGURIDAD PLATEADO****TOPE FIJA PUERTA CROMO MATE****TOPE DORADO**

# OJO MÁGICO - TOPE



**OJO MAGICO 180 ANTIQUE**



**OJO MAGICO 180 CROMO MATE**



**SEGURIDAD ESTAND. BARI NEGRO 60  
LLM 9724**



**TOPE BLANCO**

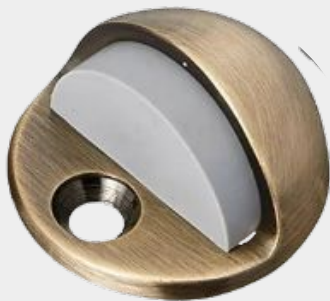

**MADERA SEGURIDAD ANOLOC**



**TOPE DE PISO CROMO MATE**

# ADITIVOS

- Alumol 295
- Limpiadores 296
- Sika 1 Sika 101 298



**ALUMOL**

ALUMOL X 0.8 KG.

ALUMOL X 3 KG.

**ANTISOL BLANCO X 20 KG.****CINTA SIKA PVC V-15 X 30 MT.****DIABLO ROJO X 350 GR. PAVCO****IGOL DENSO PLUS X 18 KG. X 3.5 KG.**

## EMULSIÓN

EMULSION ASFALTICA FORT CUARTO

EMULSION ASFALTICA FORT CUÑETE

EMULSION ASFALTICA FORT GALON

EMULSION ASFALTICA X 18 KG

EMULSION ASFALTICA X 3.5 KG





# INVECRYL - LIMPIADORES

## INVECRYL

INVECRYL 500 X 1 KG.

INVECRYL 500 X 20 KG.

INVECRYL 500 X 3 KG.

INVECRYL 500 X 4 KG.

INVECRYL 500 X 750 GR.



**LIMPIADOR DE GRIFERIA 330ML  
CORONA**



**LIMPIADOR FINAL OBRA  
X 540 ML / X 4000 ML CORONA**



**LIMPIADOR ULTRACLEAN  
CASABLANCA 900CC**



**MASTERMIX X 2 KG**

## MERULEX

MERULEX I.F.A X 20 KG.

MERULEX I.F.A X 3.5 KG.

MERULEX I.F.S TRANSP. X 3 KG.



## SIKA 1

SIKA 1 X 1 KG.

SIKA 1 X 2 KG.

SIKA 1 X 20 KG.

SIKA 1 X 4 KG.



## SIKA 101

SIKA 101 MORTERO PL PISCINA BLANCO X10KG

SIKA 101 MORTERO PL PISCINA BLANCO X50KG

SIKA 101 MORTERO PLU PISCINAS GRIS X10KG

SIKA 101 MORTERO PLU PISCINAS GRIS X25KG

SIKA 101 MORTERO PLU PISCINAS GRIS X50KG

SIKA 101 MORTERO PLUS PISCINAS BLAN X2KG

SIKA 101 MORTERO PLUS PISCINAS GRIS X2KG



**SIKA 2**

SIKA 2 X 2.5 KG.

SIKA 2 X 5.5 KG.

**SIKA ANCHORFIX S X 300 ML****SIKA ANCHORFIX S X 300 ML****SIKA MULTISEAL 10 ROLLO 10 MT.****SIKA MULTISEAL 15 ROLLO 10 MT.**

**SIKA TRANSPARENTE 10 AÑOS X 3 KG.**

**SIKA TRANSPARENTE 5 AÑOS X 3 KG.**

**SIKABOND PVA X 1 KG.**

**SIKADUR 31 ADHESIVO GRIS X 2 KG.**

**SIKADUR 32 PRIMER X 1 KG / X 3KG**

**SIKADUR ANCHORFIX-4 X 0.9**

**SIKADUR PANEL X 2 KG.**

**SIKAFELT FPP 30 0.15 M X 20 MT**

**SIKAFELT X 40 MT**

**SIKAFILL-7 POWER 7 BLANCO  
X 20 KG / X 4.2 K.**
**SIKA 101**

SIKAFLEX 1A BLANCO CARTUCHO 300 CC

SIKAFLEX 1A GRIS CARTUCHO 300 CC

SIKAFLEX CONSTRUCT BLANCO CARTUCHO 300 CC

SIKAFLEX CONSTRUCT GRIS CARTUCHO 300 CC

SIKAFLEX-221 NEGRO X 300 ML

SIKAFLEX-401 PAVEMENT SL X 300 ML



**SIKALATEX X 4.5 KG.**

**SIKASET L X 25 KG./ X 5 KG**

**EMULSION ASFALTICA FL-50  
PRO CUÑETE**

**SIKASIL-POOL CARTUCHO 300 ML**

**EMULSION ASFALTICA FL-50  
PRO GALON**

**COMPLEMENTOS**

# PINTURAS

- Viniltex 304
- Koraza 305
- Asep - Expo - Fill 307
- Pintulux 308
- Esmalte 309





Rojo Colonia  
1528



Mora  
1593



Coral  
1591



Palo de Rosa  
1567



Naranja Tentación  
1530



Naranja Fuerte  
810



Terracota  
1576



Curuba  
1566



Naranja Chic  
1518

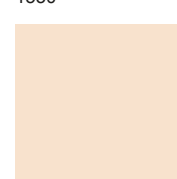

Melón  
1592



Ocre  
1526



Thai  
1578



Crema  
1509



Amarillo Profundo  
1811



Camelia  
1583



Crema Chantillí  
1516



Crema Sensación  
1537



Amarillo Vital  
1541



Avellana Boreal  
1555



Sauce  
1584



Verde Pino  
1507



Verde Aceituna  
1572



Verde Jamaicano  
1547

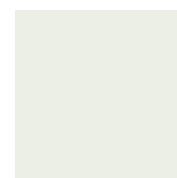

Menta Fresca  
1549

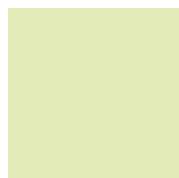

Verde Seda  
1521



Verde Cómplice  
1556



Verde Chartreuse  
1505



Verde Auténtico  
1546

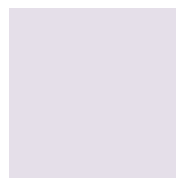

Lila  
1595



Nuez  
1585



Blanco Hueso  
1538



Verde Agua  
1504



Verde Intrépido  
1539



Azul Pacífico  
1573



Aquamarina  
1517



Azul Porcelana  
1532



Oceánico  
1587

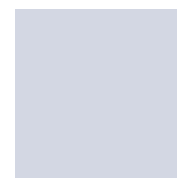



Lirio  
1581



Champaña  
1594

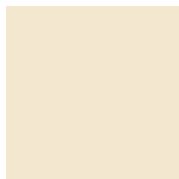
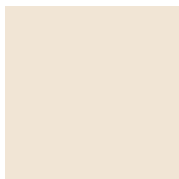
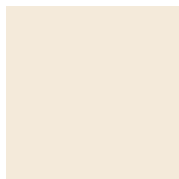
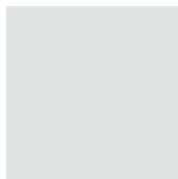
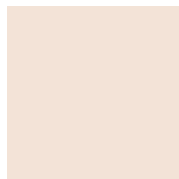
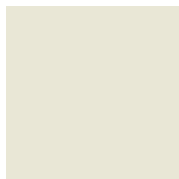
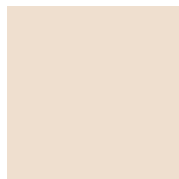
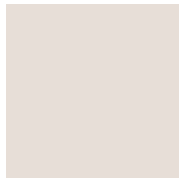
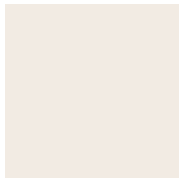
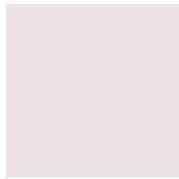

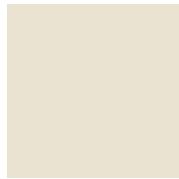
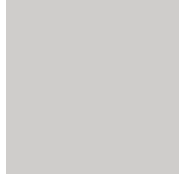
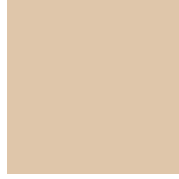
						
Blanco Luna 1571	Blanco Almendra 1561	Blanco Arena 1557	Blanco Ilusión 1543	Blanco Lila 1564	Blanco Manzana 1562	Lino Crudo 1519
						
Blanco Durazno 1565	Blanco Luminoso 1817	Blanco Invernal 1548	Gris Basalto 1502	Brama 1579	Gris Nube 1569	Trigo 1568

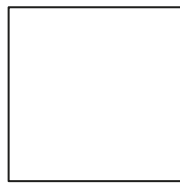







Blanco  
1401

**AQUA  
BLOCK**

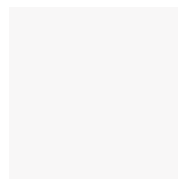
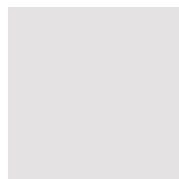

**Koraza®**  
DOBLE VIDA 10



			
Blanco 2700	Blanco hielo 2701	Gris basalto 2706	Balso 2703
			
Almendra 2702	Polen 2704	Rojo colonial 2709	Verde Amazona 27067

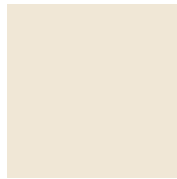

Brisa del Sur  
2687

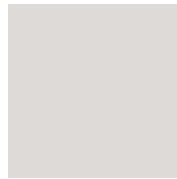

Blanco Hielo  
2682



Balso  
2698



Bajo cero  
2686



Niebla  
2663



Gris Basalto  
2675



Ciprés  
2677



Verde Espiga  
2688



Cordillera  
2664



Ceiba Claro  
2679



Océano  
2665



Marfil  
2658



Sepia  
2662



Mostaza  
2673



Nogal  
2651



Maní  
2676



Desierto  
2659



Almendra  
2678



Polen  
2661



**PINTUBOARD**



Transparente  
Se puede aplicar en cualquier  
superficie de cualquier color



**PINTURAMA<sup>®</sup>  
CUBRIENTE**

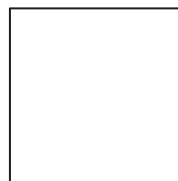

Blanco  
117800



**INTERVINIL<sup>®</sup>  
LAVABLE Y  
CUBRIENTE**



Blanco  
2501



## PINTURA ACRÍLICA ALTA ASEPSIA

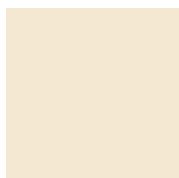

Luz costera  
OW039-P



Brisa herbal  
VD145-T



Orquídea magna  
VL061-T



Plata Fina  
NE223-D



Delfines al atardecer  
TR236-T



Banquete de primavera  
PS042-P



## PINTUCOAT® EPOXI POLIAMIDA

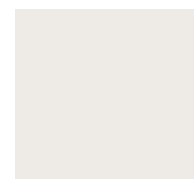

BLANCO

## PINTUCO® FILL

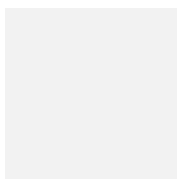

Blanco  
2750



Gris  
27505



Negro  
2752



Rojo teja  
27506



Verde Amazona  
27507





Oro 96



Bronce 77



Cobre 65



Aluminio 86



Plateado 81



Campaña 82



Verde Bronce 80

**COLORES METALIZADOS**



Blanco 11



Crema 12



Gris Plata 84



Negro 95



Amarilla 18



Ocre 61



Naranja 20



Bermellón 26



Rojo 29



Rojo Canela 94



Caoba 76



Azul Claro 35



Azul Mar 92



Azul Mediano 38



Azul Oscuro 41



Verde Turquesa 44



Verde Máquina



Verde Esmeralda

**ACUALUX**

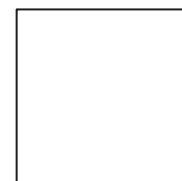









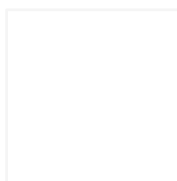
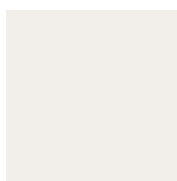







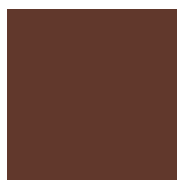





Blanco 1111



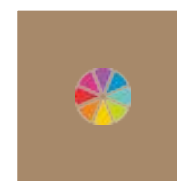

# ESMALTE DOMÉSTICO

							
Blanco 1100	Blanco 6W	Crema P-7	Marfil P-5	Amarillo P-18	Naranja P-21	Rojo Fiesta P-30	Rojo Profundo P-92
							
Vinotinto P-90	Tabaco Claro P-70	Caoba P-75	Verde Selva P-56	Verde Oliva P-93	Verde Esmeralda P-53	Verde Mar P-45	Azul Español P-40
							
Azul Verano P-50	Azul Francés P-35	Negro P-95	Negro (mate) 290W	Gris Humo P-85	Aluminio P-153	Dorado P-150	Anoloc Champaña P-155

## SOBRE PEDIDO



**IMPA CUARTO / GALÓN**

# TEJAS

- Fibrocemento Proteja 311
- Galvanizada 312
- Pvc 314
- Complementos 438



**FIBROCEMENTO PROTEJA**
**CABALLETE**
**Largo Ancho**

<b>Caballete Articulado Inferior Colón Pinta de Colombit</b>	1.2 metros	Entre 20 y 30 cm
		
<b>Caballete Articulado Superior Colón Pinta de Colombit</b>	1.2 metros	Entre 20 y 30 cm
		
<b>Caballete Fijo 15° P7 de Colombit</b>	0.92 metros	0.5 metros
		
<b>Caballete G15 Tipo C P7</b>	0.92 metros	0.5 metros
		

**TEJA**
**Longitud Ancho**

<b>Teja Colombit</b>	1.83 metros	0.92 metros
		



**CLARABOYA**
**Diámetro Altura**

<b>Claraboya No. 4 Colombit</b>	400 mm	400 mm
		
<b>Claraboya No. 6 Colombit</b>	600 mm	600 mm
		
<b>Claraboya Policarbonato Tipo Colonial</b>	600 mm	600 mm
		



**GALVANIZADA****CABALLETE**

	Largo	Ancho	Espesor
<b>Caballete Teja Arquit Guerrera C-30</b> 	1.10 metros	0.35 m	3.2 MM
<b>Caballete Teja Arquit. Galv C-26 Acesco</b> 	1.10 metros	0.30 m	2.6 MM
<b>Caballete Teja Arquit. TJ3115 C-31</b> 	1.10 metros	0.32 m	3.1 MM
<b>Caballete Teja Master 1000</b> 	2 metros	0.30 m	3.0 MM

<b>Caballete Teja THER</b> 	1.90 a 2.0 metros	0.27 m	2.5 y 3.0 MM
<b>Caballete Teja Ther 3 C</b> 	1.13 metros	0.28 m	3.0 MM
<b>Caballete Teja Ther 4 C</b> 	0.90 metros	0.30 m	3.0 MM

**TEJA ARQUITECTONICA**

	Largo	Ancho	Espesor
<b>Tejas Arquitectónicas</b> 	13 A 6 metros	1 m	C-30

## TEJA MASTER 1000

	Largo	Ancho	Espesor
<b>Teja Master 1000 C-28 ACESCO</b> 	6 metros	1 m	C-28

## LAMINA ZINC CORPACERO

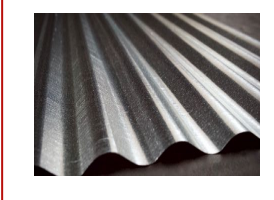
	Largo	Ancho	Espesor
<b>Láminas de Zinc Corpacero</b> 	2.15 metros	~0.914 m	C-35

## LAMINA ZINC ACESCO

	Largo	Ancho	Espesor
<b>Láminas de Zinc Aceso</b> 	2.15 metros	~0.914 m	C-34 y C-35.8

## LAMINA ZINC LISA C-30

	Largo	Ancho	Espesor
<b>Lámina Zinc Lisa C-30</b> 	2. metros	1m	C-30

**PVC****CABALLETE**

	<b>Largo</b>	<b>Ancho</b>	<b>Espesor</b>
<b>Caballete Principal de PVC Tipo Colonial</b> 	1.05 metros	0.27 metros	2.5 mm
<b>Caballete Techolit P3</b> 	1.10 metros	0.30 m	3.0 MM
<b>Caballete Teja Techoline</b> 	2 metros	0.35 m	3.2 MM

	<b>Largo</b>	<b>Espesor</b>
<b>Caballete Esquinero de PVC Tipo Colonial</b> 	1.05 metros	2 mm

**LÁMINAS**

**Longitud Ancho Espesor**

<b>Lámina Alveolar Ajovert</b>	<b>11.8 metros</b>	<b>2.1 metros</b>	<b>6 mm</b>
--------------------------------	--------------------	-------------------	-------------



**Longitud Ancho Espesor**

<b>Lámina Deck Steel 2 CMTL. Galvan</b>	<b>6 metros</b>	<b>1.00 metros</b>	<b>0.22 mm</b>
---	-----------------	--------------------	----------------



## LIMAHOYA, LIMATESA

**Longitud Ancho Espesor**

<b>Limahoya PVC Tipo Colonial</b>	<b>1.0 A 2.0 metros</b>	<b>1.15 A 0.30 metros</b>	<b>3.0 mm</b>
---------------------------------------	-----------------------------	-------------------------------	---------------



**Longitud Ancho Espesor**

<b>Limatesa PVC Tipo Colonial</b>	<b>1.0 A 2.0 metros</b>	<b>0.15 Y 0.30 metros</b>	<b>3.0 mm</b>
---------------------------------------	-----------------------------	-------------------------------	---------------



## PERFIL

**Longitud Ancho**

<b>Perfil H Cristal 11.80 para Lámina 6mm</b>	<b>11.80 metros</b>	<b>25 mm a 30 mm</b>
---	---------------------	--------------------------

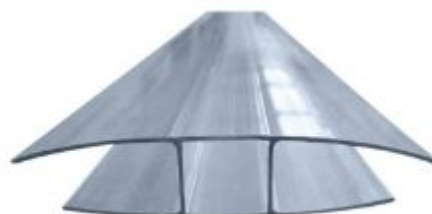

## PERFIL, TEJA ADRI PVC

**Longitud Ancho**

<b>Perfil Snap Crist 11.80 para Lámina 6mm</b>	<b>11.80 metros</b>	<b>25 mm a 30 mm</b>
--	---------------------	--------------------------



**Longitud Ancho**

<b>Perfil U Remate Aluminio</b>	<b>2.10 metros</b>	<b>30 mm</b>
-------------------------------------	--------------------	--------------



## TEJA ADRI MARFIL

**Longitud Ancho**

<b>Teja Adri Marfil</b>	<b>2.10 metros</b>	<b>30 mm</b>
-------------------------	--------------------	--------------



**TEJA AJOVER MARFIL****Longitud Ancho**

<b>Tejas Ajoover Marfil</b>	~3.05 metros	~1.05 metros.
-----------------------------	--------------	---------------

**TEJA BRONCE POLICARB****Longitud Ancho**

<b>Teja Bronce P7 Policarbonato ARKOS</b>	2.44 metros	1.05 metros.
---	-------------	--------------



**TEJA COLORTEC**

Longitud Ancho

<b>Teja ColorTec Sombra</b>	6..20 metros	1.05 metros.
-----------------------------	--------------	--------------



Largo Ancho Espesor

<b>Teja Cristal ADRI X 2.40 MT TIPO ZINC</b>	2.40 metros	1.05 metros	0.8 mm
			
<b>Teja Cristal N° 10 AJONIT Policarbonato AJOVE</b>	2.40 metros	1.05 m	1 mm
			
<b>Teja Cristal N° 4 AJONIT Policarbonato AJOVE</b>	2.40 metros	0.35 m	1 mm
			

**TEJA CRISTAL  
(ADRI,  
POLICARB, ZINC)**



	<b>Largo</b>	<b>Ancho</b>	<b>Espesor</b>
<b>Teja Cristal N° 6 AJONIT Policarbonato ADRI</b>  	<b>2.44 metros</b>	<b>1.05 m</b>	<b>1 mm</b>
<b>Teja Cristal X 1.22 MT P7 Policarbonato/Fibra</b>  	<b>1.22 metros</b>	<b>1.05 m</b>	<b>1 mm</b>
<b>Teja Cristal X 2.44 MT P3 Policarbonato ARKOS</b>  	<b>2.44 metros</b>	<b>1.05 m</b>	<b>1 mm</b>
<b>Teja Cristal X 3 MT TIPO ZINC ADRI</b>  	<b>32 metros</b>	<b>1.05 m</b>	<b>0.8 mm</b>

	<b>Largo</b>	<b>Ancho</b>	<b>Espesor</b>
<b>Teja Cristal X 3.05 MT T/Zinc Policarbonato AJOV</b>  	<b>3.05 metros</b>	<b>1.05 m</b>	<b>1 mm</b>
<b>Teja Cristal X 3.66 MT TIPO ZINC</b>  	<b>3.66 metros</b>	<b>1.05 m</b>	<b>0.8 mm</b>

## TEJA ETERNIT N.5

Longitud Ancho

Teja Eternit No. 5	1.52 metros	0.92 metros.
--------------------	-------------	--------------



## TEJA GERFOR N.6

Longitud Ancho

Teja Gerfor #6 Marfil No Min	1.83 metros	0.92 metros.
---------------------------------	-------------	--------------



## TEJA GRECA POLIC.

Longitud Ancho

Teja Greca 1.05 x 3.60 MT Bronce Polic.	3.60 metros	1.05 metros
---	-------------	-------------



**TEJA MARFIL TIPO ZINC****Longitud Ancho**









<b>Teja Marfil Tipo Zinc Ajoher</b>	<b>2.15 metros</b>	<b>1 metro</b>
-------------------------------------	--------------------	----------------

**Largo Ancho****TEJA OPAL POLICARB.****Largo Ancho**

<b>Teja Opal A360 N. 12 Trapez. Policarbonato</b>	<b>3.60 metros</b>	<b>1.05 m</b>
		
<b>Teja Opal A360 N. 6 Trapez. Policarbonato Ajoher</b>	<b>3.60 metros</b>	<b>1.05 m</b>
		

**Teja Opal N. 10  
Adri P7  
Policarbonato  
Ajoher**
**3.05 metros 0.92 m**
**Teja Opal Adri Tipo  
Zinc**
**1.80 metros 1.05 m**
**Teja Opal MT P3  
Policarbonato Arkos**
**2.44 metros 1.05 m**

## TEJAS PAVCO CRISTAL, MARFIL, PVC, SKY, SUPERTERM

	Largo	Ancho		Largo	Ancho
<b>Teja Pavco Cristal Lisa NM</b> 	1.83 metros	1.05 m	<b>Teja Sky Control Solar Gris Policarbonato ML</b> 	10 a 50 metros	1.13 m
<b>Teja Pavco Marfil Lisa</b> 	1.83 metros	1 m	<b>Teja Superter Policarbonato Trapezoidal Transparente x 5.8 m</b> 	5.8 metros	1 m
<b>Teja Pavco Marfil PVC Perfil</b> 	3.05 metros	0.91 m	<b>Teja Superterm</b> 	11.80 metros	0.90 m
<b>Teja PVC Tipo Colonial 2mm 1.05 x 5.70 mt</b> 	5.70 metros	1.05 m	<b>Teja Superterm Terracota</b> 	11.80 metros	1.07 m

## TEJA TERMOACUSTICA

**Longitud Ancho**

<b>Teja Termoacustica</b>	<b>5.90 metros</b>	<b>0.94 metros</b>
-------------------------------	--------------------	--------------------



## TEJA TRANSLÚCIDA

**Longitud Ancho**

<b>Teja Translúcida arquitectónica</b>	<b>3.66 metros</b>	<b>0.94 metros</b>
--	--------------------	--------------------



# SISTEMAS LIVIANOS

- Tablas (paneles) y Masilla 326
- Rollos de Material 327



## Tablas (paneles) y Masilla

**DRYWALL 1/2 1A**



**ETERBOARD 10MM  
1.22X2.44 COLOMBIT**



**ETERBOARD 6MM  
1.22X2.44 COLOMBIT**



**ETERBOARD 8MM  
1.22X2.44 COLOMBIT**



**ETERBOARD 8MM MAD  
1.22X2.44 COLOMBIT**



**SUPERBOARD  
ENTREP 20MM  
1.22X2.44 COLOMBI**



## Rollos de Material

**ROLLO FRESCASA ECO  
7.5MX1.2M 3.5 SIN PAP**



**ROLLO FRESCASA ECO  
7.5MX1.2M 2.5 SIN PAP**



**ROLLO FRESCASA ECO  
15.24MX1.2M 2.5 SIN P**





# TANQUES

- Acuaviva Colombit 329
- Colempaques 330
- Proco 334
- La fuente 336
- Complementos 443



**ACUAVIVA COLOMBIT**
**TANQUE ACUAVIVA 1000 LTS**

Altura      Peso

<b>TANQUE ACUAVIVA 1000 LTS. AZUL Y NEGRO COLOMBIT</b>	Altura	Peso
	1.270 mms	18 kg.

**TANQUE ACUAVIVA 2000 LTS**

Altura      Peso

<b>TANQUE ACUAVIVA 2000 LTS. AZUL Y NEGRO COLOMBIT</b>	Altura	Peso
	1.580 mms	37 kg

**TANQUE ACUAVIVA 250 LTS**

Altura      Peso

<b>TANQUE ACUAVIVA 250 LTS. AZUL Y NEGRO COLOMBIT</b>	Altura	Peso
	930 mms	7 kg.



## COLEMPAQUES

### TANQUE COLEMPAQUES 1000 LTS

Altura      Diámetro

TANQUE COLEMPAQUES 1000 LTS.	108 cm	148 cm.
------------------------------------	--------	---------



### TANQUE COLEMPAQUES 2000 LTS

Altura      Diámetro

TANQUE COLEMPAQUES 2000 LTS.	175 cm	140 cm.
------------------------------------	--------	---------



### TANQUE COLEMPAQUES 250 LTS

Altura      Diámetro

TANQUE COLEMPAQUES 250 LTS	88 cm	70 cm.
----------------------------------	-------	--------





EL NOGAL

TANQUE COLEMPAQUES 500,5000, BAJITO 1000 LTS COLEMPAQUES

## TANQUE COLEMPAQUES 500 LTS

Altura      Diámetro

TANQUE COLEMPAQUES 500 LTS.	114 cm	87 cm.
-----------------------------------	--------	--------



## TANQUE COLEMPAQUES 5000 LTS

Altura      Diámetro

TANQUE COLEMPAQUES 5000 LTS.	375 cm	235 cm.
------------------------------------	--------	---------



## TANQUE COLEMPAQUES 1000 LTS BAJITO

Altura      Diámetro

TANQUE COLEMPAQUES 1000 LTS BAJITO	44 cm	108 cm.
--	-------	---------



## TANQUE COLEMPAQUES 2000 LTS BAJITO

Altura      Diámetro

TANQUE COLEMPAQUES 2000 LTS BAJITO.	Altura	Diámetro
	44 cm	140 cm.



## TANQUE COLEMPAQUES 250 LTS BAJITO

Altura      Diámetro

TANQUE COLEMPAQUES 250 LTS BAJITO	Altura	Diámetro
	44 cm	70 cm.



## TANQUE COLEMPAQUES 500 LTS BAJITO

Altura      Diámetro

TANQUE COLEMPAQUES 500 LTS BAJITO	Altura	Diámetro
	44 cm	87 cm.





EL NOGAL

BEBEDERO COLEMPAQUES 250, 500 Y 1000 LTS COLEMPAQUES

## BEBEDERO COLEMPAQUES 250 LTS

Altura      Diámetro

BEBEDERO COLEMPAQUES 250 LTS	Altura	Diámetro
	40 cm	120 cm.



## BEBEDERO COLEMPAQUES 500 LTS

Altura      Diámetro

BEBEDERO COLEMPAQUES 500 LTS	Altura	Diámetro
	40 cm	147 cm.



## BEBEDERO COLEMPAQUES 1000 LTS

Altura      Diámetro

BEBEDERO COLEMPAQUES 1000 LTS	Altura	Diámetro
	77 cm	147 cm.



**PROCO****TANQUE PROCO 1000 LTS**

**Altura**      **Diámetro**

<b>TANQUE PROCO 1000 LTS</b>	<b>148 cm</b>	<b>108 cm.</b>
----------------------------------	---------------	----------------

**TANQUE PROCO 2000 LTS**

**Altura**      **Diámetro**

<b>TANQUE PROCO 2000 LTS</b>	<b>175 cm</b>	<b>140 cm.</b>
----------------------------------	---------------	----------------

**TANQUE PROCO 250 LTS**

**Altura**      **Diámetro**

<b>TANQUE PROCO 250 LTS</b>	<b>88 cm</b>	<b>70 cm.</b>
---------------------------------	--------------	---------------



## TANQUE PROCO 500 LTS

Altura      Diámetro

TANQUE PROCO 500 LTS	114 cm	87 cm.
-------------------------	--------	--------



## SISTEMA SÉPTICO 1000 LTS PROCO

Altura      Diámetro

SISTEMA SEPTICO 1000 LTS PROCO	144 cm	1.08 cm.
-----------------------------------	--------	----------





**LA FUENTE**
**TANQUE LA FUENTE 1000 LTS. NEGRO**

Altura      Diámetro

<b>TANQUE LA FUENTE 1000 LTS. NEGRO</b>	Altura	Diámetro
	150 cm	1000 cm.

**TANQUE LA FUENTE 2000 LTS. NEGRO**

Altura      Diámetro

<b>TANQUE LA FUENTE 2000 LTS. NEGRO</b>	Altura	Diámetro
	180 cm	120 cm.

**TANQUE LA FUENTE 250 LTS. NEGRO**

Altura      Diámetro

<b>TANQUE LA FUENTE 250 LTS. NEGRO</b>	Altura	Diámetro
	90 cm	60 cm.



**TANQUE LA FUENTE 500 LTS. NEGRO**

	Altura	Diámetro
<b>TANQUE LA FUENTE 500 LTS. NEGRO</b>	<b>120 cm</b>	<b>80 cm.</b>

**TANQUE BAJITO LA FUENTE DE 500 LTS**

	Altura	Diámetro
<b>TANQUE BAJITO LA FUENTE DE 500 LTS</b>	<b>80 cm</b>	<b>100 cm.</b>



# TELAS

- Geotextiles y Mantos 339
- Plásticos y Multisombra 342
- Rollos Especializados 343
- Complementos 444



**GEOTEXILES Y MANTOS**
**GEODRÉN VIAL TB 100 MM**

	Ancho	Unidad de medida
<b>GEODREN VIAL TB 100 MM (1 MT ANCHO) ML PAV</b>	1 m	Metro lineal.

**GEOTEXTIL NT1600 MT**

	Ancho	Unidad de medida
<b>GEOTEXTIL NT1600 (2 MT. ANCHO) MT LIN</b>	2 m	Metro lineal.

**GEOTEXTIL NT1600 (3.50 MT ANCHO)**

	Ancho	Unidad de medida
<b>GEOTEXTIL NT1600 (3.50 MT ANCHO) M2 PAVC</b>	3.50 m	Metro Cuadrado.



**GEOTEXTIL NT1600S**

	Ancho	Unidad de medida
<b>GEOTEXTIL NT1600S (3.50 MT ANCHO) M2 PAV</b>	<b>3.50 m</b>	<b>Metro cuadrado.</b>

**GEOTEXTIL NT2000**

	Ancho	Unidad de medida
<b>GEOTEXTIL NT2000 (3.80 MT ANCHO) M2 PAV</b>	<b>3.80 m</b>	<b>Metro cuadrado.</b>

**GEOTEXTIL NT2500**

	Ancho	Unidad de medida
<b>GEOTEXTIL NT2500 (3.50 MT ANCHO) M2 PAV</b>	<b>3.50 m</b>	<b>Metro Cuadrado.</b>



## GEOTEXTIL T2400

	Ancho	Unidad de medida
GEOTEXTIL T2400 (3.85 MT ANCHO) M2 PAVC	3.85 m	Metro cuadrado.



## MANTO DURA 2.5 (3000)

	Espesor
MANTO DURA 2.5 (3000)	3 mm



## MANTO DURA 3MM (3500)

	Espesor
MANTO DURA 3MM (3500)	2.5 mm



## MANTO METALEX PRO 2.5 FIBERGLASS

	Espesor
MANTO METALEX PRO 2.5 FIBERGLASS	2.5 mm



**PLÁSTICOS Y MULTISOMBRA**
**PLÁSTICO NEGRO X 3 MT. ANCHO C-6 MT.**

	Ancho	Unidad de medida
PLÁSTICO NEGRO X 3 MT. ANCHO C-6 MT.	3 m	Metro cuadrado.

**PLÁSTICO NEGRO X 4 MT. ANCHO C-6 MT**

	Ancho
PLÁSTICO NEGRO X 4 MT. ANCHO C-6 MT.	4 m

**MULTISOMBRA 35% X 4 MT**

	Ancho
MULTISOMBRA 35% X 4 MT. ANCHO MT.	4 m

**MULTISOMBRA 65% X 4 MT. ANCHO MT.**

	Ancho
MULTISOMBRA 65% X 4 MT. ANCHO MT.	4 m



## ROLLOS ESPECIALIZADOS

### ROLLO ALUTEX 20 CM X 10 MT.

	Ancho	Unidad de medida
ROLLO ALUTEX 20 CM X 10 MT.	20 cm	Rollo.



### ROLLO MANTO SIN LLAMA PRO20

	Área	Unidad de medida
ROLLO MANTO SIN LLAMA PRO20 10 M <sup>2</sup>	10 m	Metro cuadrado.



### ROLLO TELA ASFÁLTICA INST. ECOTEX

	Longitud	Unidad de medida
ROLLO TELA ASFÁLTICA INST. ECOTEX X 20 MT.	20 m	Rollo.





**ROLLO TELA ASFÁLTICA CTE N.30 TEXSA**
**Unidad de medida**
**ROLLO TELA ASFÁLTICA CTE N.30 TEXSA**
**Rollo.**

**ROLLO TEXSA TAPE ALUMINIO**
**Unidad de medida**  
**Longitud**
**ROLLO TEXSA TAPE ALUMINIO 10 CM X 5 MT.**
**5 m**
**Rollo**

**ROLLO TEXSA TAPE ROJO COLONIAL**
**Unidad de medida**  
**Longitud**
**ROLLO TEXSA TAPE ROJO COLONIAL 10 CM X 5 MT.**
**5 m**
**Rollo.**

# ELECTRODOMÉSTICOS

- Calentadores de Agua 346
- Campanas Extractoras 349
- Cubiertas de Cocina 351
- Hornos 356
- Mesones y Muebles de Cocina 358



## CALENTADORES DE AGUA

### Calentador 5.5 Lts HACEB 9002236

	Alto	Ancho
Calentador 5.5 Lts HACEB 9002236	47 m	33 cm



### Calentador Therm 1000 5.5 Lts GN DA BOSC

	Alto	Ancho
Calentador Therm 1000 5.5 Lts GN DA BOSC	47 m	33 cm



### Calentador Therm 1000 O 5.5 Lts GLP DA

	Alto	Ancho
Calentador Therm 1000 O 5.5 Lts GLP DA	47 m	33 cm



## Calentador Therm 1400 TF 10 Lts GLP BOSC

**Alto**      **Ancho**

Calentador Therm 1400 TF 10 Lts GLP BOSC	<b>Alto</b>	<b>Ancho</b>
	51 m	35 cm



## Calentador TN 10 Lts HACEB 9002239

**Alto**      **Ancho**

Calentador TN 10 Lts HACEB 9002239	<b>Alto</b>	<b>Ancho</b>
	50 m	35 cm



## Calentador Therm 2200 TN 13 Lts GLP BOSC

**Alto**      **Ancho**

Calentador Therm 2200 TN 13 Lts GLP BOSC	<b>Alto</b>	<b>Ancho</b>
	56 m	37 cm



**Calentador Therm 5600 F 18 Lts GLP BOSCH**

	Alto	Ancho
Calentador Therm 5600 F 18 Lts GLP BOSCH	67 m	44 cm

**Calentador Therm 5600 F 21 Lts GLP BOSCH**

	Alto	Ancho
Calentador Therm 5600 F 21 Lts GLP BOSCH	70 m	45 cm



## CAMPANAS EXTRACTORAS

### Campana CX 4200 V2 A.Inox Challenger

	Alto	Ancho
Campana CX 4200 V2 A.Inox Challenger	40 m	60 cm



### Campana KALA C-60 V-2 Inox HACEB 9001857

	Alto	Ancho
Campana KALA C-60 V-2 Inox HACEB 9001857	40 m	60 cm



### Campana Tofu Inox C-60 V3 9002651 HACEB

	Alto	Ancho
Campana Tofu Inox C-60 V3 9002651 HACEB	40 m	60 cm



**Campana CX 4310 V3 Negra Challenger**

	<b>Alto</b>	<b>Ancho</b>
<b>Campana CX 4310 V3 Negra Challenger</b>	<b>40 m</b>	<b>60 cm</b>

**Campana Isla 60 3V Inox CX 4660 Challenger**

	<b>Alto</b>	<b>Ancho</b>
<b>Campana Isla 60 3V Inox CX 4660 Challenger</b>	<b>35 m</b>	<b>60 cm</b>



**CUBIERTAS DE COCINA****Cubierta 4P 55x45 GN Vid Tem 5692 Contin**

	Alto	Ancho
Cubierta 4P 55x45 GN Vid Tem 5692 Contin	4 cm	55 cm

**Cubierta 4P Con EE 61x51 GN Inox 5531 CO**

	Alto	Ancho
Cubierta 4P Con EE 61x51 GN Inox 5531 CO	4 cm	61 cm

**Cubierta 6043 A.Inox 4P 43x58  
Challenger**

	Alto	Ancho
Cubierta 6043 A.Inox 4P 43x58 Challenger	4 cm	43 cm





**Cubierta Acero Sésamo Inox 60x51 9002053**

	Alto	Ancho
Cubierta Acero Sésamo Inox 60x51 9002053	4 cm	43 cm

**Cubierta SG 6140EI Inox GP 4P 58x51 Challenger**

	Alto	Ancho
Cubierta SG 6140EI Inox GP 4P 58x51 Challenger	4 cm	58 cm

**Cubierta Tofu Inox 60-51 GN 9003286**

	Alto	Ancho
Cubierta Tofu Inox 60-51 GN 9003286	4 cm	60 cm



### Cubierta Tandoori Inox HF60-51 GN 9002294

	Alto	Ancho
Cubierta Tandoori Inox HF60-51 GN 9002294	4 cm	60 cm



### Cubierta 6762 Cristal Negro 4P 52x60 CHA

	Alto	Ancho
Cubierta 6762 Cristal Negro 4P 52x60 CHA	4 cm	52 cm



### Cubierta APL 5P CG-76 Cristal GN 9000748

	Alto	Ancho
Cubierta APL 5P CG-76 Cristal GN 9000748	4 cm	76 cm



## Cubierta Arezzo 4P CG-66 Inox GN 9000838

	Alto	Ancho
Cubierta Arezzo 4P CG-66 Inox GN 9000838	4 cm	66 cm

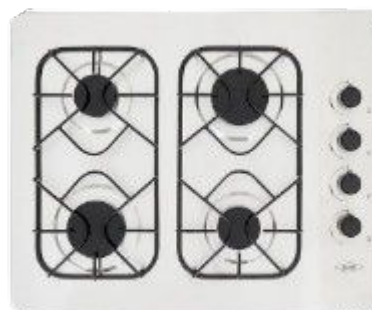

## Cubierta ASL CG 60 Cristal MF GN 9000745

	Alto	Ancho
Cubierta ASL CG 60 Cristal MF GN 9000745	4 cm	60 cm



## Cubierta Assento 4P CG-60 Ino GN 9000742

	Alto	Ancho
Cubierta Assento 4P CG-60 Ino GN 9000742	4 cm	60 cm



**Cubierta CG 60-43 Cristal ML 9000732**

	Alto	Ancho
Cubierta CG 60-43 Cristal ML 9000732	4 cm	60 cm

**Cubierta Sésamo 4P GN CG-60X43 9002050**

	Alto	Ancho
Cubierta Sésamo 4P GN CG-60X43 9002050	4 cm	60 cm

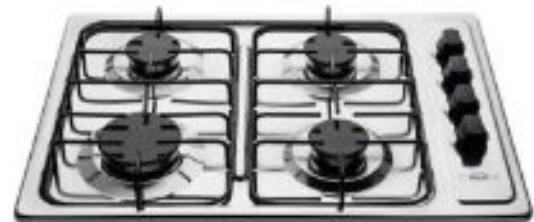
**Cubierta Tandori Cristal 60-51GN 9002295**

	Alto	Ancho
Cubierta Tandori Cristal 60-51GN 9002295	4 cm	60 cm



## HORNOS

### Horno Arezzo ARF-60ELEC220 HACEB 9000895

	Alto	Ancho
Horno Arezzo ARF-60ELEC220 HACEB 9000895	59 cm	59 cm



### Horno de Convección Eléctrico 2750 220V Challenger

	Alto	Ancho
Horno de Convección Eléctrico 2750 220V Challenger	60 cm	60 cm



### Horno Gas Natural 2545 Challenger

	Alto	Ancho
Horno Gas Natural 2545 Challenger	60 cm	60 cm



**Horno HG Tandoori 60 Negro GP 9002370**

	<b>Alto</b>	<b>Ancho</b>
<b>Horno HG Tandoori 60 Negro GP 9002370</b>	<b>60 cm</b>	<b>60 cm</b>

**Horno Mixto a Gas 2555 Challenger**

	<b>Alto</b>	<b>Ancho</b>
<b>Horno Mixto a Gas 2555 Challenger</b>	<b>60 cm</b>	<b>60 cm</b>



## MESONES Y MUEBLES DE COCINA

### Mesón 1.50 Mt. 4 Ptos Poz. Der. 9001945

	Alto	Ancho
Mesón 1.50 Mt. 4 Ptos Poz. Der. 9001945	85 cm	60 cm



### Mesón 1.50 Mt. 4 Ptos Poz. Izq. 9001946

	Alto	Ancho
Mesón 1.50 Mt. 4 Ptos Poz. Izq. 9001946	85 cm	60 cm



# COCINA

- Cocinas 360
- Lavaplatos 361
- Mesones y Pocetas 369





**COCINAS**

**COCINA CRETA 1.50  
CORONA CM0571601**



**COCINA PRAGA DE  
1.80 DERECHA**



**COCINA SAVONA 1.80  
IZQUIERDA CORONA**



**LAVAPLATOS**

**COMBO LAVAPLATOS  
A.INOX 1X50 COMP  
MES DR**



**COMBO LAVAPLATOS  
A.INOX 1X50 COMP  
MES IZ**



**COMBO LAVAPLATOS  
A.INOX  
43X53+CANAST+**



**COMBO LAVAPLATOS  
A.INOX  
60X40+CANAST+**



## LAVAPLATOS COCINA

**LAVAPLATOS A INOX  
60X40 NORTH HUEC  
3.1/2**



**LAVAPLATOS A INOX  
ESCUR IZQ MEZ 1X50  
NOR**



**LAVAPLATOS A INOX  
SENCILLO 50X35  
NORTH**



**LAVAPLATOS A. INOX  
1.20X52 MESON  
DERECHO**



## LAVAPLATOS COCINA

**LAVAPLATOS A.INOX  
1.20X52 MESON  
IZQUIERDO**



**LAVAPLATOS A.INOX  
1X52 MESON  
DERECHO**



**LAVAPLATOS A.INOX  
1X52 MESON IZQ  
MONOC**



**LAVAPLATOS A.INOX  
1X52 MESON  
IZQUIERDO**



## LAVAPLATOS COCINA

**LAVAPLATOS A.INOX  
50X35**



**LAVAPLATOS A.INOX  
60X40 EMPOTRAR**



**LAVAPLATOS A.INOX  
60X40 SUBMONTAR**



**LAVAPLATOS A.INOX  
TRIPLE POCETA 1X51**



## LAVAPLATOS COCINA

**LAVAPLATOS  
ALUMINIO 60 X 40 NO  
MIN**



**LAVAPLATOS CUBET  
DERECHA 1X50  
9342253**



**LAVAPLATOS CUBETA  
IZQ 1X50 93422535**



**LAVAPLATOS A.INOX  
TRIPLE POCETA 1X51**



## LAVAPLATOS COCINA

**LAVAPLATOS DOBLE  
POCETA 94X43 REF  
204053**



**LAVAPLATOS DOBLE  
REC ALTO BRILL  
94030205**



**LAVAPLATOS DOBLE  
RECT. 69X40 94062105**



**LAVAPLATOS  
FUNDIDO 60X40 NO  
MIN**



## LAVAPLATOS COCINA

**LAVAPLATOS LUNA 38  
BL REDONDO  
94044405**



**LAVAPLATOS POCETA  
CENTR 1.20X50  
93434505**



**LAVAPLATOS RECT  
SATINADO 50X40  
94018112**



**LAVAPLATOS RECT.  
PULIDO 56X34  
94085505**





## LAVAPLATOS COCINA

**LAVAPLATOS LUNA 38  
BL REDONDO  
94044405**



**LAVAPLATOS POCETA  
CENTR 1.20X50  
93434505**



**LAVAPLATOS RECT  
SATINADO 50X40  
94018112**



**MESONES Y POCETAS**

**MESON INTEGRAL  
1.82X0.52 4 PTOS POZ.  
DER**



**MESON RADIANTE  
1.50X0.52 4 PTOS POZ.  
DER**



**POCETA A INOX  
SUBMONTAR 54X34  
NORTH**



**POCETA A. INOX 53X43**



# GALVANIZADO

- Accesorios de tubo galvanizado 371
- Niples galvanizados 375
- Complementos 445



## ACCESORIOS DE TUBO GALVANIZADOS

### ACCESORIOS DE TUBO GALVANIZADO

**CODO GALV 1/2**



**SEMICODO GALVANIZA DE 3/8**



**CODO GALV 3/8**



**SEMICODO GALVANIZADO DE 3/4**



**SEMICODO GALV DE 3**



**REDUC. BUJE GALV. 1 X 1/2**



## ACCESORIOS DE TUBO GALVANIZADOS

**REDUC. BUJE GALV. 1  
X 3/4**



**REDUC. BUJE GALV.  
3/4 X 1/2**



**REDUC. COPA GALV. 1  
X 1/2**



**REDUC. COPA GALV. 1  
X 3/4**



**REDUC. COPA GALV.  
1/2 X 3/8**



**REDUC. COPA GALV.  
2X 1**



## ACCESORIOS DE TUBO GALVANIZADOS

**TAPON BUJE GAL  
1.1/2**



**TAPON BUJE GAL 2**



**TAPON BUJE GALV. 1**



**TAPON BUJE GALV. 1/2**



**TAPON COPA GALV 1**



**TAPON COPA GALV  
1.1/2**



## ACCESORIOS DE TUBO GALVANIZADOS

**TAPON COPA GALV.  
1/2**



**UNION GALV 1.1/4**



**UNION GALV 1/2**



**UNION GALV 2.1/2**



**UNION GALV 3**



## NIPLES GALVANIZADOS

**NIPLE GALV. 1 X 5**



**NIPLE GALV. 1 X 8**



**NIPLE GALV. 2 X 10**



**NIPLE GALV. 2 X 13**



**NIPLE GALV. 2 X 5**



**NIPLE GALV. 3/4 X 10**





## NIPLES GALVANIZADOS

**NIPLE GALV. 3/4 X 20**



**NIPLE GALV. 3/4 X 25**



**NIPLE GALV. 3/4 X 5**



**NIPLE GALV. 3/4 X 8**



**NIPLE GALV. 3/8 X 13**



**NIPLE GALV. 3/8 X 15**

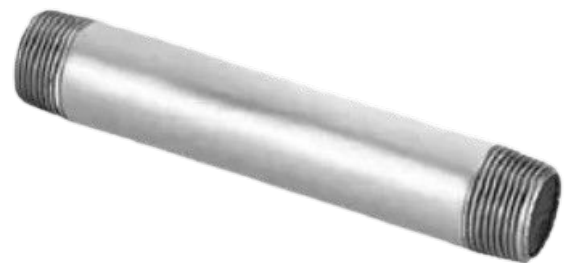

# NIPLES GALVANIZADOS

## NIPLE GALV. 3/8 X 18



## NIPLE GALV. 3/8 X 20



## NIPLE GALV. 3/8 X 25



# MANGUERAS

- Abrazaderas 379
- Acoples y Racores 380
- Mangueras 381
- Aspersores y Boquillas 385
- Pistolas y Conectores 386
- Uniones y Tés 387



**ABRAZADERAS****ABRAZADERA 1.1/2 X 2****ABRAZADERA 1/2 NO MIN****ABRAZADERA 3 X 3 1/2****ABRAZADERA 3 X 4****ABRAZADERA 3/4 X 1****ABRAZADERA METALICA  
3/4**

**ACOPLES Y RACORES****ACOPLE 3/4 RAPIDO  
MANGUERA 863****RACOR JUEGO ACOPLES  
RAP CON ADAPT PCP****RACOR PLASTICO  
MANGUERA****REDUC. MANGUERA 1  
X 1/2****REDUC. MANGUERA 1  
X 3/4****REDUC. MANGUERA 1.1/2  
X 1/2**

**MANGUERAS****MANGUERA JARDIN C-40 MT.****SISTEMA RIEGO 1 C-40 MT****SISTEMA RIEGO 1/2 C-40 MT****MANGUERA NIVEL CRISTAL 5/16 C-30 MT.****SISTEMA RIEGO 1.1/2 C-40 MT****SISTEMA RIEGO 2 C-40 MT**

## SISTEMA RIEGO 1/2 C-40 MT



## SISTEMA RIEGO 2 C-40 MT



**REDUC. MANGUERA 1.1/2 X  
3/4**



**REDUC. MANGUERA  
1.1/2X1**



**REDUC. MANGUERA 1.1/4  
X 1/2**



**REDUC. MANGUERA  
1.1/4X 1**



**REDUC. MANGUERA 2  
X 1**



**REDUC. MANGUERA 2 X  
1.1/2**





**REDUC. MANGUERA 2 X 1.1/4**

**REDUC. MANGUERA 2 X 1/2**

**REDUC. MANGUERA 2 X 3/4**

**REDUC. MANGUERA 3 X 2**

**REDUC. MANGUERA 3/4 X 1/2**

## Aspersores y Boquillas

**ASPERSOR 1/2 X 14 ROS NPT  
BOQ VERDE PCP**



**BOQUILLA ROCIADORA  
ANTIDESLIZANTE PCP**



**BOQUILLA  
ROCIADORA ECO PCP**



## Pistolas y Conectores

### PISTOLA MANGUERA METAL. 1895



### CONECTOR EN YEE AMARILLO PCP



**Uniones y Tés****TEE MANGUERA 1****UNION MANGUERA 1.1/4****UNION MANGUERA 3/4****UNION MANGUERA 1.1/2****UNION MANGUERA 3****UNION MANGUERA- TUBO  
1**

**UNION MANGUERA-TUBO  
1.1/2**

**UNION  
MANGUERA-TUBO 1/2**

**UNION  
MANGUERA-TUBO 2**

**UNION MANGUERA-TUBO  
3/4**

# HERRAJERIA

- Cargas y Anclajes 390
- Grapas y Clavos 391
- Tornillos y Accesorios 395



## Cargas y Anclajes

### CARGA MASTER C-22



### CHAZO 3/8 PLASTICO



### CLAVO ANCLAJE 1"



# GRAPAS Y CLAVOS HERRAJERIA

## Grapas y Clavos

### KILO GRAPAS 1



### KILO GRAPAS 1.1/4



### KILO PUNTILLA 4



### KILO PUNTILLA 5



### KILO PUNTILLA 6



### KILO PUNTILLA 7





## GRAPAS Y CLAVOS HERRAJERIA

**KILO PUNTILLA 8**



**LIBRA CLAVO PARA ZINC**



**LIBRA PUNTILLA 1**



**LIBRA PUNTILLA 1.1/2**



**LIBRA PUNTILLA 1.1/4**



**LIBRA PUNTILLA 1/2**



## GRAPAS Y CLAVOS HERRAJERIA

**LIBRA PUNTILLA 2**



**LIBRA PUNTILLA 2.1/2**



**LIBRA PUNTILLA 3**



**LIBRA PUNTILLA 3 1/2**



**LIBRA PUNTILLA 3 1/2  
X 370 GR.**



**LIBRA PUNTILLA ACERO 1  
ESTRIADA**



# GRAPAS Y CLAVOS HERRAJERIA

**LIBRA PUNTILLA ACERO 1.1/2  
ESTRIADA**



**LIBRA PUNTILLA ACERO  
1.1/2 LISA**



**LIBRA PUNTILLA ACERO 2  
ESTRIADA**



**LIBRA PUNTILLA  
ACERO 2.1/2  
ESTRIADA**



**LIBRA PUNTILLA  
ACERO 2.1/2 LISA**



**LIBRA PUNTILLA ACERO 3  
ESTRIADA**



## Tornillos y Accesorios

**TORNILLO 3/16X1 CON  
TUERCA Y ARANDELA**



**TORNILLO 6X7/8 PUNTA  
AGUDA**



**TORNILLO 8X1.1/4 PUNTA  
AGUDA**



**TORNILLO 8X1.1/4  
PUNTA BROCA**



**TORNILLO 8X1.1/4  
PUNTA BROCA CON  
ALAS**



**TORNILLO AUTOP. 12-14X5  
CUBIERTA CABEZA**



## TORNILLOS Y ACCESORIOS

**TORNILLO AUTOP. 12X3/4**



**TORNILLO AUTOP. METAL 1.1/2 25 MM THERM.**



**TORNILLO AVELLANANTE 8X1.3/4 CON ALAS**



**TORNILLO ESPIGO THERMOAC. 25 CM**



**TORNILLO ESTRUCT. 7X7/16 PUNTA AGUDA**



**TORNILLO ESTRUCT. 8X1/2 PUNTA AGUDA**



## TORNILLOS Y ACCESORIOS

**TORNILLO ESTRUCT. 8X1/2  
PUNTA BROCA**



**TORNILLO EXTRAPLANO  
8X3/4 PUNTA AGUDA**



**TORNILLO FIJADOR ALA  
1.1/4 19 MM THERM.**



**TORNILLO FIJADOR  
ALA THERMOAC. 7/8**



**TORNILLO PANEL 6X1  
PUNTA AGUDA**



**TORNILLO PANEL 6X1  
PUNTA BROCA**



# HERRAMIENTAS

- Manual 399
- Agrícola 404
- Complementos TEJAS 437
- Complementos de Gres 439
- Complementos Tanques 442
- Complementos Cementos 444
- Complementos Galvanizado 445
- Otros Productos 446



**RANGER**

QUALITY TOOLS



**AEROGRAFO ALTA PRESION RANGER**

**HERRAGRO**



**ALICATE 8 UNIVERSAL HERRAGRO**

**STANLEY**



**ALICATE HACEN 10 84221 STANLEY**

**RANGER**

QUALITY TOOLS



**ALICATE RANGER (UIVERSAL 8)**

**MPTOOLS**



**ALICATE UNIVERSAL MPTOOLS PROF 7**

**MPTOOLS**



**ALICATE UNIVERSAL MPTOOLS PROF 8**



# HERRAMIENTAS



**Makita**

**ANGLE GINDER 115MM +  
PULIDORA MAKITA**

**HERRAGRO**



**AZADÓN 3120 HERRAGRO**



**BALAKLAVA**



**BALDE PLASTICO**



**HERRAGRO**

**BARRA HERRAGRO (12 LBS - 14 LBS  
16 LBS - 18 LBS)**



**BISTURI METALICO 18MM**

**WERK  
INDUSTRIAL****BROCA 3/8 SDS PLUS WERK****DEWALT****BROCA 5/64 HSS SKIN CARD DEWALT****DEWALT****BROCA 5/8 DW00772 SDS PLUS DEWALT****WERK  
INDUSTRIAL****BROCA 5/8 SDS PLUS WERK****Construrama****BROCA 7/16 DWA32716G HSS  
GOLD FERROUS DW****BROCA ACERO 5/32 7478 CONSTRURAMA**

**BROCA MPTOOLS HSS**

BROCA MPTOOLS HSS 1/2

BROCA MPTOOLS HSS 1/4

BROCA MPTOOLS HSS 1/8

BROCA MPTOOLS HSS 3/32

BROCA MPTOOLS HSS 3/8

BROCA MPTOOLS HSS 5/16

BROCA MPTOOLS HSS 5/32

BROCA MPTOOLS HSS 7/16

BROCA MPTOOLS HSS 7/64

BROCA MPTOOLS HSS 9/64

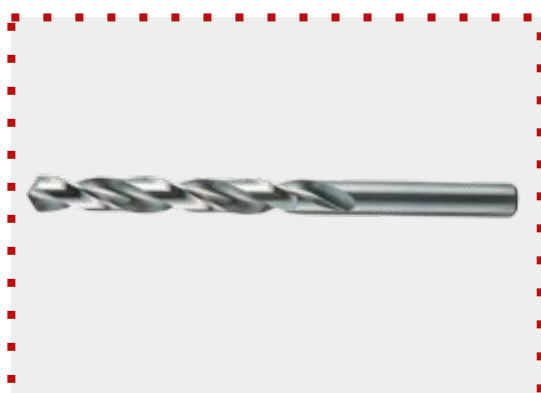
**BROCA 1/16 METAL HSS ACERO 867****BISTURI METALICO 18MM**



**BROCA MULTI HSS, MADERA,  
CONCRETO 1/2x160**



**BROCA MURO 1/2X4**



**BROCA MURO 5/16X4**



**BROCAS MPTOOLS  
comb 1/8a3/8pz(3a10mm)**



**CABO AZADON**



**CABO PALA**

**CABO PICA**

**HERRAGRO**
**CARRETILLA MET LLAN ANTIP  
BUGGY 3000 HER**

**HERRAGRO**
**CARRETILLA MET LLAN NEUMAT  
BUGGY 3000 HER**

**IMDICO**  
DESDE 1979
**CARRETILLA MET LLANTA  
ANTIP. 3000 IMDICO**

**HERRAGRO**
**CARRETILLA PLAS LLAN ANTIP  
BUGG 5000 HER**

**HERRAGRO**
**CARRETILLA PLAS LLAN NEUM  
BUGGY 5000 HER**



**CARRETILLA PLAST LLANTA  
ANTIP. 5000 IMDI**



**CASCO INDUS. PLAST. AMARILLO A1400**



**CASCO INDUS. PLAST. CON  
RATCHET AMARILLO**



**CASCO INDUS. PLAST. CON  
RATCHET BLANCO**



**CARRETILLA PLAS LLAN ANTIP  
BUGG 5000 HER**



**CEPILLO ALAMBRE CURVO ONDUL  
LATON HERRAG**



**CINCEL DWA0802 SDS PLUS DEWALT**



**CINCEL MPTOOLS 1/2X10"**



**CIZALLA CORTA PERNOS (18 - 24- 36)  
HERRAGRO**



**COMPRESOR 2hp 1.5KW prof**



**CARRETILLA PLAS LLAN ANTIP  
BUGG 5000 HER**

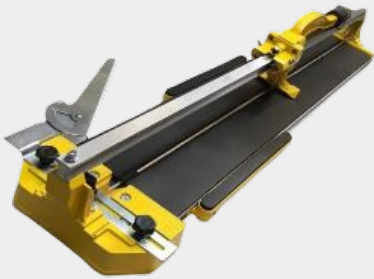

**COPA T.11 #53346 MPTOOLS C80**

**Construrama****CORTABALD. RUBI PRACTIC 61 24985****CORTADOR TUBO 7474 CONSTRURAMA**
**RANGER**  
 QUALITY TOOLS
**CORTADORA DE CERÁMICA  
1200mm RANGER****CORTADORA TUBO PVC 2017151****CRUCETA (SEPARADOR CERAMICA)  
1 MM, 2MM, 3MM****CUÑA NIVELACION 3MM**





**DECAMETRO MFPtools 12.5mmx30m  
JC3008**





**DECAMETRO MPTOOLS FV 12.5mmx20m**



**DISCO C/METAL 4.1/2X1/16X7/8  
PREMIER CAR**

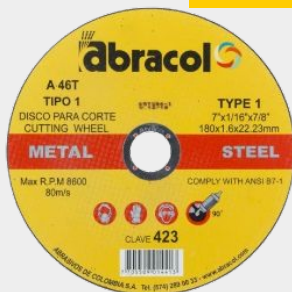

**DISCO C/METAL 4.1/2X3/64X7/8  
ABRACOL**

**DISCO C/METAL 7X1/16 ABRACOL**



**DISCO C/METAL 7X1/16  
PREMIER CARBORUNDUM**



**DISCO C/METAL 7X1/16  
PREMIER CARBORUNDUM**

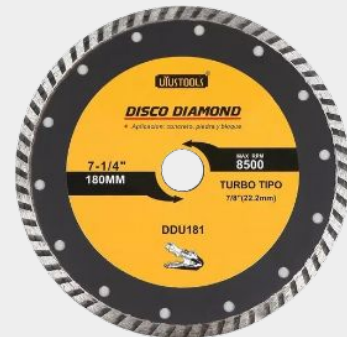

**DISCO CONCRETO CONTINUO 7  
7514 CONSTRURA**



**DISCO CORTE NO FERROSO  
9X1/8X7/8 ABRACOL**



**DISCO FINO 4 115MM GR60 BOSCH**



**DISCO MADERA 9 7508 CONSTRURAMA**

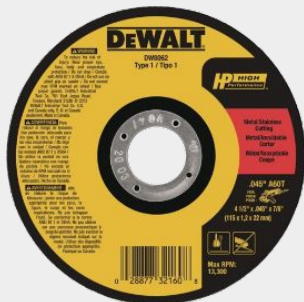

**DISCO FLAP ZINCORNIUM RANGER  
(4-1/2 120#) (4-1/2 80#)**

**DEWALT**

**DISCO FINO 4.1/2X0.045X7/8  
DW8062 DEWALT**

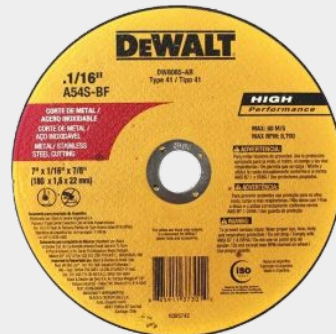
**DEWALT**

**DISCO FINO 7X0.055X7/8 DW8065  
DEWALT**

**DEWALT**

**DISCO FINO 9 DW8067 DEWALT**

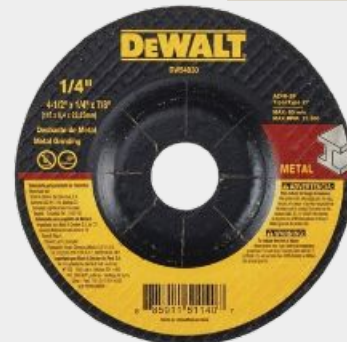
**DEWALT**

**DISCO P/METAL 4.1/2X1/4X7/8  
T27 DW54830**

**DEWALT**

**DISCO P/METAL 7X1/4X7/8 T27 DW54850**

**MPTOOLS**

**DISCO SIERRA CIRC TUG  
MPTOOLS 40d 7-1/4**

**DISCO DIAMANTADO ABRACOL**

DISCO DIAMANTADO 4.1/2 CONTINUO ABRACOL

DISCO DIAMANTADO 4.1/2 SEGMENTADO ABRACOL

DISCO DIAMANTADO 4.1/2 TURBO ABRACOL

DISCO DIAMANTADO 7 CONTINUO ABRACOL

DISCO DIAMANTADO 7 SEGMENTADO ABRACOL

DISCO DIAMANTADO 7 TURBO ABRACOL

DISCO DIAMANTADO 9 SEGMENTADO ABRACOL

DISCO DIAMANTADO 9 TURBO ABRACOL

**DISCO DIAMANTADO MP TOOLS**

DISCO DIAMANTADO MPTOOLS 4-1/2 X7/8

DISCO DIAMANTADO MPtools 7"x7/8" SEGMENT

DISCO DIAMANTADO MPTOOLS 9x7/8SEGMENTADO





**DISCO SUPERFINO 4.1/2  
BNA12 NORTON**



**DISCO SUPERFINO 7X1/16  
BNA12 NORTON**



**DISCO TRONZADORA 14X3/32X1  
DW44640 DEWAL**



**ENGRAPADORA RANGER PROF  
(4-14MM) W/400PC**



**ESCALERA TIJERA (X 1.20 MT., X 1.80 MT.  
X 2.40 MT., X 3.05 MT. X 3.60 MT.)**



**ESCOBA BARRE PRADO 5370-26D  
101509 BELLO**



**ESCOBA P/JARDIN MPTOOLS**  
met.18x22d



**ESCUADRA METAL 45600 STANLEY**



**ESCUADRA PROF 203MM/8 46532**  
**STANLEY**



**ESPATULA DRYWALL (# 10) (#12)**



**ESPATULA 1.1/2 F30 CABO MADERA**



**ESPÁTULA (2, 2.1/2 , 3, 4, 5, 6)**

## FLEXOMETRO STANLEY

FLEXOMETRO X 3 MT. 30608 STANLEY

FLEXOMETRO X 5 MT. 30615 STANLEY

FLEXOMETRO X 8 MT. 30626 STANLEY



## FLEXOMETRO RANGER

FLEXOMETRO RANGER PRO 16mmx3m 382w

FLEXOMETRO RANGER PRO 25MMX5MM

FLEXOMETRO RANGER PRO 32MMX8M



## FLEXOMETRO LUFKIN

FLEXOMETRO TRAD. X 3 MT. L510CME LUFKIN

FLEXOMETRO TRAD. X 5 MT. L516CME LUFKIN

FLEXOMETRO TRAD. X 8 MT. L525CME LUFKIN

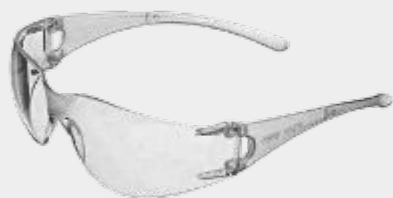

**ESTOPA BOLSA X 200 GR.****ESTOPA BOLSA X 250 GR. GOYA****Gafa ELEMENT CLARO KIMB****Gafa ELEMENT OSCURO KIMB****HIDROLAVADORA BW13-B3  
BLACK & DECKER****JUEGO INSTALAR CERRADURAS  
MPTOOLS 71841**



## KILO DE SOLDADURA ARCO

KILO SOLDADURA 6011 1/8 WEST ARCO

KILO SOLDADURA 6013 1/8 SOLDARCO WESTARC

KILO SOLDADURA 6013 1/8 WEST ARCO

KILO SOLDADURA 6013 3/32 SOLDARCO WESTAR

KILO SOLDADURA 6013 3/32 WEST ARCO

KILO SOLDADURA 7018 1/8 WEST ARCO

KILO SOLDADURA 7018 3/32 SOLDARCO

KILO SOLDADURA 7018 3/32 WEST ARCO

KILO SOLDADURA 7018 5/32 WEST ARCO

KILO SOLDADURA ALUMINIO 1/8 WEST ARCO



**KIT TALADRO INALAMBRICO 8V  
+ ACCES B&D**



**KIT TALADRO INALAMBRICO  
1/2" 20V DEWALT**

# LIJADORA - LLANA



**KIT NEUMATICO Y KORZA 400-8**



**LIJADORA DE PALMA 1/4  
PLIEGO DWE6411-B3**



**LIJADORA ROTORBITAL DWE6421-B3  
DEWALT**



**LLANA TI DENTADA HERRAGRO**



**LLANA LISA ECONOMICA  
MANGO PLAST**



**LLANA LISA METALICA**

# LLANA - LLAVES



**LLANA LISA MPTOOLS M/ MAD  
280X130 MM**



**LLANA PLASTICA ROJA GRANDE**



**LLANTA CARRETILLA ANTIPINCHAZO  
HERRAGRO**



**LLAVE AJUSTABLE 10" RANGER**



**LLAVE AJUSTABLE 10" STANLEY**



**LLAVE P/TUBO MPTOOLS TP 10**



**LLAVE TUBO (10" 254MM) (12")  
(14") (8") STANLEY**



**MANILA GANADERA (N. 10 MT) (N. 12 MT)  
(N. 14 MT) (N. 6 MT) (N. 8 MT)**



**MARCO SEGUETA PREMIUM 67201218  
NICHOLSON**



**MARCO SEGUETA PROF RANGER 12  
PJ-01A**



**MARCO SEGUETA STANDAR 18206200  
NICHOLSON**



**MARTILLO (25MM, 29MM) MANGO  
MADERA HERRAGRO**



**MARTILLO CABO MAD (20 OZ) (7 OZ)  
STANLEY**



**MARTILLO DE UÑA PROFESION. 27MM  
RANGER**



**MASCARA P/SOLDAR MAVERICK EMPIRE**



**MASCARILLAS 8557 CONSTRURAMA**



**MAZO CAUCHO RANGER m/FV 24OZ  
#36414**



**MEZCLADOR DE PINTURA RANGER**



**MEZCLADORA 1/2 BULTO MOTOR  
ELECTRICO 210**



**MINI INVERSOR RANGER 180 AMP  
110/220v**



**MINIPULIDORA 4.1/2 D28112/DWE4212  
DEWALT**



**MOTOSIERRA 288XP HUSQUVARNA**



**MOTOSIERRA 372XP HUSQUVARNA**



**MOTOTOOL RANGER (KIT) X183 PZ**



**MOTOTOOL SERIE 3000/10+  
GRABADOR DREMEL**



**NIVEL ALUMINIO (18) (24) STANLEY**



**OVILLO HILO ATAFACIL X 130 MT.**



**PALA CUADRADA # 2 HERRAGRO**



**PALA CUADRADA # 4 HERRAGRO**



**PALA CUADRADA #2 AGROTEK**

**PALA HOYADORA AGROTEK****PALA PUNTA 32X27X71CM CON MANGO TRAMONTI****PALA REDONDA (#2) (#4) HERRAGRO****PALA REDONDA (#2) (#4) IMDICO****PALA SANTANDER AGROTEK****PALA SANTANDER HERRAGRO**



**PALA SANTANDER INDICO****PALADRAGA AGROTEK****PALADRAGA C-16 5408 HERRAGRO****HERRAGRO****PALUSTRE N. 10, N. 5 MM, N. 6 MM, N. 7 MM  
, N. 8 MM, N. 9 MANGO MADERA****PALUSTRE PROF RANGER MAN  
(MADERA 9) (MADERA 5) (MADERA 7).****PAR GUANTE BIC. TRITON C-35 TALLA 10**



**PAR GUANTES POLIURET. NEGRO  
(TALLA 10) (TALLA 8) (TALLA 9).**



**PAR GUANTE CARNAZ REFOR EN  
CARNAZA CORTO**



**PAR GUANTE CARNAZ REFOR  
EN VAQUETA (CORTO) (LARGO).**



**PAR GUANTE POLIEST. RECUBIER  
LATEX CORTO**



**PAR GUANTE VAQUETA TIPO  
INGENIERO REFORZ**



**PAR GUANTE VAQUETA TIPO  
INGENIERO SENCIL**

**PICA HERRAGRO****PICO 3106-34 HERRAGRO****PINZA CORTAFRIO 7"****PINZA DE PUNTA****PISTOLA ANCHORFIX-4/3001****PISTOLA CALAFATEO DOBLE RANGER**

**PISTOLA CARGA C-22 TIRO A MASTER****PISTOLA DE AIRE CALIENTE D26411-B3  
DEWAL****PISTOLA DE CALOR 750/1500W  
120V/60Hz****PISTOLA P/AGUA 8 FUNCION  
RANGE(ZINC ALL)****PISTOLA P/SILICONA T.ESQUELETO  
MPTOOLS****PISTOLA PULVERIZADORA  
ALTA PRESION RANGE**



**PISTOLA RANGER P/SILICONA  
T.ESQUELETO 9**



**PLATON AMARIL CARRETIILLA MET  
BUG 3000 HE**



**PORRA (10 LBS.) (12 LBS.) (14 LB.) (16 LB.)  
(18 LB.) (2 LB.) (4 LB.) CON CABO**



**PULIDORA 4.1/2 DWE4010-DWE750  
DEWALT**



**PULIDORA 4.1/2 DWE4120-B3F DEWALT**



**PULIDORA 4.1/2 G720K-B3 CAJA  
PLAST. B&D**

**PULIDORA 7 28491/DWE491 DEWALT****PULIDORA 9 28490/DWE490 DEWALT****PULIDORA IND 4.1/2 DWE4315 DEWALT****PULIDORA PROF 9" 2200W 6600RPM  
+ MAKITA****PUNTA DE TALADRO.S2 MPtools  
ph 2x50mm****REMACHADORA POP MPTOOLS  
(BLISTER)10"**



**RODEL RUBI (10 MM 01946) (18 MM 01950)  
(6 MM 01945) (8 MM 01958)**



**ROLLO CINTA SEÑALIZACION X 100 MT.**



**ROTOMARTILLO D25133K DEWALT**



**ROTOMARTILLO D25333K-B3 950W  
DEWALT**



**RUEDA d/cte BLISTER 10x4.3x2.9  
p/540920**



**RUEDA d/cte BLISTER 18x6x3.8mm  
p/540920**



**RUEDA d/cte BLISTER 6.2X1.4X1mm  
p/540920**



**RULA 24 CACHA ROJA HERRAGRO**



**SEGUETA HSS BIMETAL 12"X1 1/2 18D**



**SEGUETAS HERRAGRO**



**SEGUETAS NICHOLSON**



**SIERRA CALADORA RANGER 650W  
3000rpm**





**SIERRA CIRCULAR 7.1/4 1400W DWE5615  
DWAL**



**SIERRA CIRCULAR 7.1/4 GKS-190/150  
BOSCH**



**SIERRA CIRCULAR RANGER 7 1400W  
4800rpm**



**SIERRA MARMOL MAKIT.4-3/8+1200W  
13800RPM**



**SOPORTE CUÑA NIVELACION**



**TALADRO GBH 224 SDS BOSCH**

**TALADRO GSR 120 LI BATERIA BOSCH****TALADRO INALAMBRICO RANGER 3/8  
12V****TALADRO MPTOOLS INALAMBRICO 1/2"****TALADRO PERC. 1/2 DW505 DEWALT****TALADRO PERC. 1/2 GSB 16RE BOSCH****TALADRO PERC. GSB 550W RE 1/2  
BOSCH**



**TALADRO PERCUTOR 1/2 DWD024  
DEWALT**



**TALADRO PERCUTOR MAKITA 5/8 MT  
VERDE**



**TALADRO ROT. 1/2 DW245 DEWALT**



**TALADRO ROT. GBM 10 RE BOSCH**



**TAPABOCAS**



**TENAZA MPTOOLS UÑA Y BOLA 8 #15341**

**TIJERA AVIACION DER 14564 STANLEY****TIJERA AVIACION IZQ 14562 STANLEY****TIJERA AVIACION RECT 14563 STANLEY****TIJERA PODADORA MPTOOLS 210mm****TRONZADORA 14 D28720-B3 DEWALT****TRONZADORA GCO220 2200W BOSCH**

**TRONZADORA RANGER 14 2500W****BROCA MPTOOLS HSS 3/16****CARRETA 3100 ANTIPIN PLATON Y CHASIS MET****ADAPTADOR P/DRYWALL RANGER Ph#2**

## COMPLEMENTOS DE TEJAS



Longitud Ancho

<b>Cinta Antidust Tape Mathiesen</b>	<b>11 metros</b>	<b>50 mm</b>
		
<b>Cinta Microperforada Ajovert</b>	<b>11.80 metros</b>	<b>0.25 m</b>
		

## ACCESORIOS

Longitud Altura

Cubrezócalo Cristal Ajove Lam Alveo	2.10 metros	8 a 10 cm
		

## GANCHOS

Longitud Ancho Espesor

Gancho Teja	10 y 20 cm	1.5 a 3 cm	3 mm
			

Largo Ancho Altura

Escurridero PVC Tipo Colonial	45 a 60 cm	35 a 40 cm	12 y 15 cm
			

Longitud Ancho

Gancho Vidrio Claraboya	5 y 10 cm	1 y 2 cm
		

## KITS

Longitud Material

Kit Conector Tran Tapa-Base 11.8 MT Math	11.8 metros	PVC de alta resistencia
		

Longitud Material

Kit Conector Tran Tapa-Base 11.8 MT Nelt	11.8 metros	PVC de alta resistencia
		

# COMPLEMENTOS DE GRES





# GUARDAESCOBAS

Longitud Ancho

<b>Guardaesc. Maple x 1 MT</b>		
	1 metro	10 cm

Longitud Ancho

<b>Guardaescoba Arboledas 8x25 MTL</b>		
	25 cm	8 cm

Longitud Ancho

<b>Guardaesc. Mármol Beige Brown x 1 MT</b>		
	1 metro	10 cm

Longitud Ancho

<b>Guardaescoba Arena 10x30 UNID</b>		
	30 cm	10 cm

Longitud Ancho

<b>Guardaescoba Almendro 10x30 UNID</b>		
	30 cm	10 cm

Longitud Ancho

<b>Guardaescoba Betania 8x25 MTL</b>		
	25 cm	8 cm



EL NOGAL

GUARDAESCOBA, PASAMANOS, TOLETE GRES COMPLEMENTOS

Longitud Ancho

<b>Guardaescoba Durania 8x25 MTL</b>		
	25 cm	8 cm

Longitud Ancho

<b>Guardaescoba Matizado 10x30 UNID</b>		
	30 cm	10 cm
<b>Guardaescoba Toledo 8x25 MTL</b>		
	25 cm	8 cm

## PASAMANOS

Longitud Altura

<b>Pasamanos Matizado Doble 25x24x4 MT. LIN</b>		
	25 cm	24 cm

## TOLETE

Longitud Ancho

<b>Tolete CTE Curití</b>		
	5 cm	15 cm
<b>Tolete CTE</b>		
	5 cm	15 cm

Espesor Ancho

<b>Pasamanos Sencillo MT. LIN</b>		
	3 a 5 cm	7 a 10 cm



## COMPLEMENTOS TANQUES

### TAPAS

Altura Diámetro

**TAPA TANQUE 250  
LTS.  
COLEMPAQUES**

94 cm

78 cm



**TAPA TANQUE 500  
LTS. COLOMBIT**

94 cm

78 cm



**TAPA TANQUE 500  
LTS. COLOMBIT**

72 cm

42 cm



### ANILLO

Altura

**ANILLO ROSETÓN  
PLASTICO  
ESTANDAR NO  
MIN**

50 mm y  
100 mm



### TAQUES

Altura Diámetro

**TANQUE BOTELLA  
COLEMPAQUES  
2200 LTS**

175 cm

140 cm



### SISTEMA SÉPTICO

Altura Diámetro

**TANQUE BOTELLA  
COLEMPAQUES  
2200 LTS**

150 cm

120 cm



## COMPLEMENTOS TANQUES

### SIKA MANTO 3MM LISO CLIMA CÁLIDO

	<b>Espesor</b>	<b>Área</b>
<b>SIKAMANTO 3MM LISO X 10 M<sup>2</sup>. CLIMA CÁLIDO</b>	<b>3 mm</b>	<b>10 metros cuadrados</b>



### ROLLO TEXSA TAPE ROJO COLONIAL

	<b>Ancho</b>	<b>Unidad de medida</b>
<b>ROLLO TEXSA TAPE ROJO COLONIAL 10 CM X 5 MT.</b>	<b>2.10 m</b>	<b>Metro Lineal</b>



**COMPLEMENTOS CEMENTOS**

**Caja Contador  
Cemento con Tapa**



**Lavatrápero  
Enchapado**



**Lavatrápero Granito  
40 x 40**

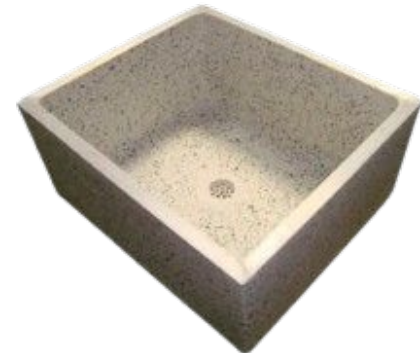

**COMPLEMENTOS GALVANIZADO**
**TEE GALV 1**

**TEE GALV 3/4**

**TEE GALV DOBLE 3/4**

**TAPON CORTE AGUA  
1/2**

**TAPON CORTE AGUA  
1/4**

**UNIVERSAL GALV 1/2**

**TEE GALV DOBLE 3/4****TAPON CORTE AGUA  
1/4**

**OTROS PRODUCTOS**

**BINDA BOQUILLA ACRILICA  
X 10 KG. BEIGE**



**PAPELERA 3 LTS. CANECA  
ANT**



**TABLA DE CONSTRUCCION  
30 CM X 2.5 CM X 3**



**TABLA DE CONSTRUCCIÓN**

